



TRANSDUCER OF TEMPERATURE AND STANDARD SIGNALS P30U TYPE



USER'S MANUAL



Contents

| | |
|--|-----------|
| 1. APPLICATION | 6 |
| 2. TRANSDUCER SET | 8 |
| 3. BASIC REQUIREMENTS, OPERATIONAL SAFETY | 8 |
| 4. INSTALLATION | 9 |
| 4.1. Mounting method | 9 |
| 4.2. External connections diagrams | 10 |
| 5. OPERATION | 11 |
| 5.1. P30U transducer front panel description | 11 |
| 5.2. Messages after switching on the power | 12 |
| 5.3. Key functions | 13 |
| 5.3.1. Individual key functions | 13 |
| 5.3.2. Functions of key combinations | 15 |
| 5.3.3. Programming matrix | 16 |
| 5.4. Programming transducer parameters | 17 |
| 5.4.1. Changing the value of the selected parameter | 22 |
| 5.4.2. Changing floating-point values | 22 |
| 5.4.3. Programmable transducer parameters | 23 |
| 5.5. Transducer functions | 40 |
| 5.5.1. Measurement input | 40 |
| 5.5.1.1. Interface RS-485 Master mode | 40 |
| 5.5.1.2. Interface RS-485 Monitor mode | 43 |
| 5.5.1.3. Median filter | 44 |
| 5.5.1.4. Averaging time | 46 |
| 5.5.1.5. Maximum and minimum values of measured signals | 46 |

| | |
|--|----|
| 5.5.1.6. Mathematical operations on measured values | 46 |
| 5.5.1.7. Mathematical functions | 48 |
| 5.5.1.8. Input individual characteristic | 48 |
| 5.5.1.9. Displayed value range limitation | 50 |
| 5.5.2. Analog output | 50 |
| 5.5.2.1. Analog output individual characteristic | 50 |
| 5.5.2.2. Analog output overflow management | 51 |
| 5.5.3. Alarm and power outputs | 55 |
| 5.5.4. LCD display | 57 |
| 5.5.4.1. Custom unit definition | 59 |
| 5.5.4.2. Displaying two values with their units | 60 |
| 5.5.5. Writing and reading transducer configuration from file..... | 61 |
| 5.5.5.1. Storing the transducer configuration file | 61 |
| 5.5.5.2. Reading the transducer configuration file | 61 |
| 5.6. Default settings | 62 |
| 5.7. Firmware update | 67 |
| 5.8. Archiving measured values | 69 |
| 5.8.1. Transducer memory structure | 69 |
| 5.8.2. Internal memory | 70 |
| 5.8.2.1. Record structure | 71 |
| 5.8.2.2. Downloading archived data from the internal memory..... | 72 |
| 5.8.3. Archiving configuration | 73 |
| 5.8.4. Memory card or internal file system memory (option)..... | 76 |
| 5.8.5. Archive file structure | 79 |
| 5.9. RS-485 Interface | 80 |
| 5.9.1. Serial interface connection..... | 80 |

| | |
|---|-----|
| 5.9.2. MODBUS protocol description | 81 |
| 5.9.3. Description of the implemented functions | 82 |
| 5.9.4. Register map | 86 |
| 5.9.5. Read and Write registers | 89 |
| 5.9.6. Read-only registers..... | 110 |
| 5.10. 10/100-BASE-T Ethernet interface | 117 |
| 5.10.1. Connecting 10/100-BASE-T Ethernet interface | 117 |
| 5.10.2. WWW server | 119 |
| 5.10.2.1. Website general view | 120 |
| 5.10.2.2. WWW user selection | 120 |
| 5.10.3. FTP server | 122 |
| 5.10.3.1. FTP user selection | 122 |
| 5.10.4. TCP/IP Modbus | 124 |
| 6. ACCESSORIES..... | 125 |
| 7. ERROR CODES | 125 |
| 8. TECHNICAL DATA..... | 127 |
| 9. ORDERING CODE | 132 |

1. APPLICATION

The P30U programmable transducer is designed to convert temperature, resistance, direct voltage and direct current signals into a standard DC voltage or DC current signal. The output signal is galvanically isolated from the input signal and power supply. The transducer is fitted with a 2x8 LCD screen.

Features of the P30U transducer:

- converting measured values into any output signal based on an individual linear characteristic,
- calculating measured values using one of five implemented mathematical functions,
- calculating measured values based on a 21-point individual characteristics,
- one or two NO (normally open) relay alarms operating in 6 modes
- auxiliary power supply 24V DC 30mA switched on/off by software (options),
- indication of exceeding the alarm values set,
- programming alarm and analog outputs with a reaction to selected input value (main input, auxiliary input or RTC),
- real time clock (RTC) with independent battery supply
- recording the input signals in programmed time periods in the internal memory and on an SD/SDHC card (option),
- internal archive memory with 534336 record capacity,
- automatic decimal point setting,
- preview of preset parameters,
- password protected parameter change
- RS-485 interface support with the MODBUS protocol in RTU mode,
- programmable averaging time,
- Median filter with various number of samples
- SD/SDHC memory cards support – compatible with FAT and FAT32 file system (option),
- RS-485 interface Master mode – ability to poll a single slave device

- RS-485 interface Monitor mode – ability to monitor transmission on RS-485 interface and react to the value of the selected register.
- 10/100 BASE-T Ethernet interface (option)
 - protocol: Modbus TCP/IP, HTTP, FTP,
 - services: WWW server, FTP server, DHCP client



Fig.1. Various variants of P30U transducer.

2. TRANSDUCER SET

| | |
|-----------------------------------|--------|
| - P30U transducer | 1 pc. |
| - user's manual | 1 pc. |
| - guarantee card | 1 pcs. |
| - plug-able screw terminal blocks | 4 pcs. |

3. BASIC REQUIREMENTS, OPERATIONAL SAFETY

The transducer meets the requirements of EN 61010-1 standard in terms of operational safety.



Safety precautions:

- The assembly and installation of electrical connections must be carried out by a person authorized to install electrical equipment.
- Before switching the transducer on, one must check the correctness of connections.
- The device is destined to be installed and used in industrial electromagnetic environment conditions.
- The building installation should be equipped with a switch or an automatic circuit breaker located near the device, which should be easy accessible by the operator and properly marked.
- Removal of the transducer housing during the warranty period may cause its invalidation.

4. INSTALLATION

4.1. Mounting method

P30 transducers should be mounted on a 35 mm rail bracket according to PN-EN 60715. Dimensions and method of mounting are shown in figure 2.

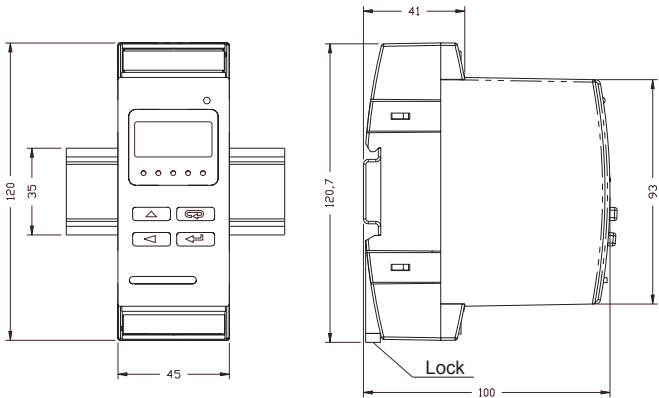

Fig.2. Overall dimensions and method of mounting the transducer.

4.2. External connections diagrams



| | | | |
|--------------------|---|---|--|
| Measured signal | Thermoresistor or resistance measurement in 3 wire system | Thermoresistor or resistance measurement in 2 wire system | Thermocouple or voltage $-5...20\text{mV}$, $-75...75\text{mV}$, $-200...200\text{mV}$ |
| Connection diagram | | | |
| Measured signal | Voltage $-24...24\text{V}$ $-10...10\text{V}$ | Current $-20...20\text{ mA}$ | SUPP- power supply A1 - NO relay no. 1 OUT - voltage or current analog output INPUT - measuring input RS- 485 - RS-485 interface |
| Connection diagram | | | P30U-XX1XXXXX A2 - NO relay no. 2  P30U-XX2XXXXX A2 - auxiliary supply 24 V d.c. 30 mA  |

Fig.3. External connections diagram of the P30U transducer

For the connection of input signals in environments with a high noise level, shielded wires should be used.

5. OPERATION

5.1 P30U transducer front panel description

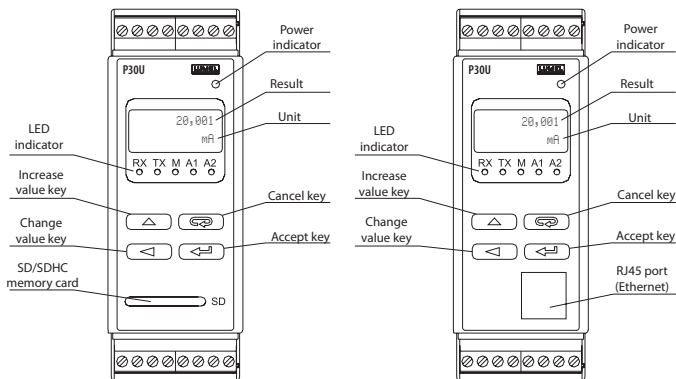

Fig.4. Front panel description

Note: The memory card (option) should be inserted to the transducer slot with contacts facing down

LED indicator description:

RX – green diode – Data reception on RS-485 indicator

TX – yellow diode – Data transmission on RS-485 indicator

M – red diode – full internal memory indicator or writing file to SD/SDHC memory indicator, when the internal memory usage exceeds 95%, the diode is constantly on, if the transducer operates with an installed memory card, then the LED flashes when data is being written on the card.

A1 – red diode – indicator of switching on the first alarm

A2 – red diode – indicator of switching on the second alarm or 24V d.c. power supply

Power indicator – green diode.

5.2. Messages after switching on the power

After connecting external signals and switch the power supply on which is signalled with a green LED (power indicator), the transducer displays the type, current firmware version and the serial number. If the transducer is equipped with Ethernet interface (P30U-X2XXXXXX) IP address is displayed after serial number (stored in memory or received from the DHCP server).

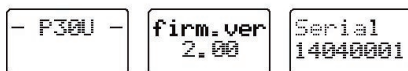

Three rectangular boxes containing text. The first box contains '- P30U -'. The second box contains 'firm.ver' on the top line and '2.00' on the bottom line. The third box contains 'Serial' on the top line and '14040001' on the bottom line.

Fig.5. Fig.5. Start-up messages of a transducer not equipped with an Ethernet interface.

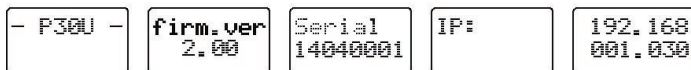

Five rectangular boxes containing text. The first box contains '- P30U -'. The second box contains 'firm.ver' on the top line and '2.00' on the bottom line. The third box contains 'Serial' on the top line and '14040001' on the bottom line. The fourth box contains 'IP:'. The fifth box contains '192.168' on the top line and '001.030' on the bottom line.

Fig.6. Start-up messages of a transducer equipped with an Ethernet interface.

After about five seconds, the transducer automatically switches to operating mode; it makes a measurement and converts it into an analog output signal. It displays the measured value in the top row of the display and auxiliary information in the bottom row of the display (section 5.5.4). The LED indicator signals the transmission status on the RS-485 interface, status of the internal memory use and alarm states. If transducer is equipped with an Ethernet interface, Ethernet services start-up: WWW server, FTP server, TCP/IP Modbus

5.3. Key functions

5.3.1. Individual key functions



- accept key

- enters programming mode (hold for about 3 seconds),
- navigates the menu – level select,
- enters parameter value change mode,
- accepts the changed parameter value,
- changes the content displayed in the lower line of the display,
- switching the transducer power supply on while holding this key enters the software update mode through the RS-485 interface, connection parameters: rate 9600 kb/s, mode 8N2.



- increase value key

- displays the maximum value of the main input,
- enters the parameters group level,
- navigates the selected level
- changes the value of a selected parameter – increase value,



 - change digit key

- displays the minimum value of the main input,
- enters the parameters group level,
- navigates the selected level,
- changes the value of a selected parameter – switches to the subsequent digit,
- switching the transducer power supply on while holding this key enters the software update mode through the RS-485 interface, connection parameters: rate 15200 kb/s, mode 8N2.



 - cancel key

- enters the transducer parameters preview menu (hold for about 3 seconds),
- exits the transducer parameters preview menu,
- changes the content displayed in the lower line of the display,
- cancel the parameter change,
- completely cancels the programming mode (hold for about 3 seconds).
- switching the transducer power supply on while holding the key forces reading transducer configuration from P30U_PAR.CON file stored on an external SD/SDHC memory card or in the internal file system memory (depending on the manufacturing variant).



5.3.2. Functions of key combinations

  - hold for about 3 seconds



- clear alarm indication; this action works only when the alarm indication memory function is switched on;

  - hold for about 1 second



- clears the maximum value for the measured value

  - hold for about 1 second

- clears the minimum value for the measured value

  - hold for about 1 second

- unmounts the SD/SDHC memory card enabling safe removal – for transducer equipped with an external SD/SDHC memory slot

  - hold for about 1 second

- force start copying the archive from the internal memory into the SD/SDHC memory card– for transducer equipped with an external SD/SDHC memory slot
- force start copying the archive from the internal memory to the file system memory – for transducer equipped with an Ethernet interface; this action enables downloading current archive data files from the transducer via FTP protocol

Push and hold the programming key  for about 3 seconds to enter the programming matrix. The programming matrix can be protected with a safety code.

5.3.3. Programming matrix

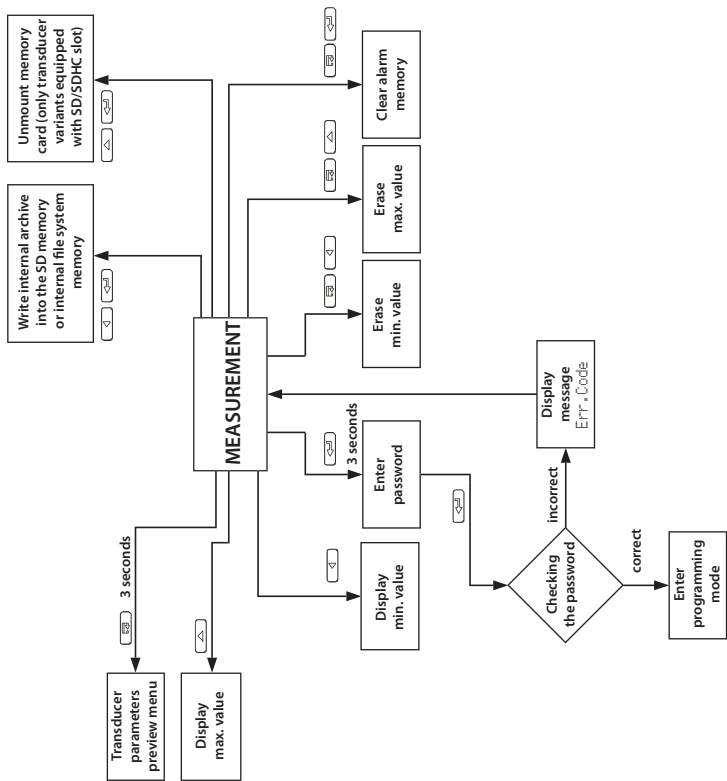







Fig.7. P30U operation algorithm

5.4. Programming transducer parameters

Press and hold for about 3 seconds  key to enter the programming matrix. If access is password protected, transducer will ask for password. If the entered password is incorrect, Err. Code message will be displayed. Correct password enables access to the programming matrix. Fig. 8 shows the matrix in the programming mode. Use  or  to select the menu level or navigate the parameters of a given sub-level. The parameter symbol is displayed at the upper line of the display, while the parameter is displayed at the lower line of the display. Press  to edit parameter. Press  to cancel changing parameter. Press and hold  to exit the programming matrix and enter the measurement mode. If the transducer remains inactive for 30 seconds in the parameter programming mode, it will exit the programming mode and display the displayed value.



| | | | | | |
|--------------------------------------|--|---|--|-------------------------------|--|
| Settings Input | Input | AvgTime | Compens. | Comp. Val | Median |
| Input parameters | Measured value type | Averaging time | Compensation type | Manual compensation value | Number of median filter samples |
| Settings Ind. Char | Point No | X1 | Y1 | ... | X21 |
| Individual characteristic parameters | Number of individual char.points | The first point of the individual char. Point x | The first point of the individual char. Point y. | | The last point of the individual char. |
| Settings Display | Decimal P | Unit | Over Lo | Over HI | Bcklight |
| Display parameters | Minimum decimal point of the displayed value | Displayed unit | Lower display range threshold | Upper display range threshold | Display backlight time |
| Settings Alarm 1 | Param. A1 | Type A1 | OverLoA1 | OverHi A1 | DI yOnA1 |
| Alarm 1 parameters | Input value type for alarm 1 | Alarm 1 type | Alarm 1 lower threshold | Alarm 1 upper threshold | Alarm 1 activation delay |
| Settings Alarm 2 | Param. A2 | Type A2 | OverLoA2 | OverHi A2 | DI yOnA2 |
| Alarm 2 parameters | Input value type for alarm 2 | Alarm 2 type | Alarm 2 lower threshold | Alarm 2 upper threshold | Alarm 2 activation delay |
| Settings Output | Param. An | AnIn Lo | AnIn Hi | AnOut Lo | AnOut Hi |
| Analog output parameters | Value which controls analog output | Low level input signal | High level input signal | Low level output signal | High level output signal |





| | | | | |
|---|---|---|--|--|
| Math Fun | | | | |
| Mathematical function on measured value | | | | |
| Y21 | | | | |
| The last point of the individual char. | | | | |
| Bckl . I nt | Di sp. Reg | Dec. P 2 | Uni t2 | |
| LCD display backlight intensity | Number of register displayed at the lower line of the display | Minimum decimal point of the second displayed value | Second displayed value unit | |
| DI y0ffA1 | OnLockA1 | SgKeepA1 | | |
| Alarm 1 deactivation delay | Alarm 1 reactivation delay | Alarm 1 indication mode | | |
| DI y0ffA2 | OnLockA2 | SgKeepA2 | | |
| Alarm 2 deactivation delay | Alarm 2 reactivation delay | Alarm 2 indication mode | | |
| OverServ | OvrIn Lo | OvrIn Hi | OvrOutLo | OvrOutHi |
| Overflow management activation | Lower input overflow | Upper input overflow | Value expected on output at input lower overflow | Value expected on output at input upper overflow |





| | | | | | |
|---|--|---|--|---|--|
| Settings Mbus 485 RS-485 interface parameters | Address Device address | ModeUnit Transmis- sion frame mode | BaudRate Transmission rate | Base. Reg Number of pol- led/monitored base register in Master/Mo- nitor mode | No. ofVal Number of polled values in Master / Monitor mode |
| | No. OfErr Number of acceptable errors in ModbusRS-485 answers | | | | |
| Settings Archive Archiving parameters | Arch. Val Archived value selection | Param. Ar Value type triggering conditional archiving | Ar. Mode Archiving type | OverLoAr Archive lower threshold | OverHi Ar Archive upper threshold |
| Settings Service Service parameters | Fabr. Par Write standard parameters | Securi ty Enter password | Ti me Set current time | Date Set current date | AutoTi me Auto change of summer/ winter time |
| Settings Ethernet Ethernet parameters | DHCP DHCP client on/off | addrI P32 B3,B2 byte of IP address (IPv4) | addrI P10 B1,B0 byte of IP address (IPv4) | mask 32 B3,B2 byte of subnet mask | maska 10 B1,B0 bajt maski pod- sieci |
| | received from DHCP or entered manually when DHCP is off, | | | | |
| | Addr mTCP Device address for TCP/IP Mod- bus service | Por tMbus TCP/IP Modbus port | Ti meMbu TCP/IP Modbus service close time when inactive | no. c. TCP Number of allowed simultaneous connections with TCP/IP Modbus service | p. comFTP FTP server command port number |



| | | | | |
|---|---|---|---------------------------------------|--|
| Val Type Type of polled / monitored values | Interv. Polling interval in Master RS-485 mode | AnswTime Maximal answer time Master mode | Mode RS-485 interface working mode | Mast. Fun Selection of modbus Master function |
|---|---|---|---------------------------------------|--|

| | | | |
|------------------------------|---------------------------------------|--|---|
| Ar. Time Archiving period | Ar. Erase Erasing internal archive | Rec. ToSD Copy internal archive into SD/SDHC card | Param. SD Percent of internal archive use which triggers automatic copying to SD/SDHC card |
|------------------------------|---------------------------------------|--|---|

| | | |
|---|-------------------------------------|--|
| Di sptest LCD display and indicating diodes test | Language Menu language selection | SaveFile Force writing transducer configuration file into an SD/SDHC card |
|---|-------------------------------------|--|

| | | | | |
|--|--|--|--|--|
| gate 32 B3,B2 byte of default gateway address | gate 10 B1,B0 byte of default gateway address | MAC 54 B5,B4 byte of the transducer's MAC address | MAC 32 B3,B2 byte of the transducer's MAC address | MAC 10 B1,B0 byte of the transducer's MAC address |
|--|--|--|--|--|





format: B3.B2.B1.B0



format : B5:B4:B3:B2:B1:B0

| | | | | |
|---|-------------------------------------|------------------------|--|--|
| Port FTP FTP server data port number | portHTTP HTTP server port number | LnkSpeed Link speed | EthStdPa Set standard Ethernet interface parameters | Rel ni tEt Apply changes of Ethernet interface parameters |
|---|-------------------------------------|------------------------|--|--|

Fig.6. Programming matrix.



5.4.1. Changing the value of the selected parameter

To increment the selected parameter, press . Press the key once to increase the value by 1. If value of 9 is increased, the digit will switch to 0. To change the digit, press . Press  when editing the most significant digit to edit the digit sign character – press  to edit the sign character.

To accept the set parameter, press . The parameter will be stored. Press  to cancel change during edition.

5.4.2. Changing floating-point values

The change is carried out in two stages (the transition to the next stage follows after pressing the  key).

- setting the dot position (00000., 0000.0, 000.00, 00.000, 0.0000); The  key moves the dot to the left, and  key moves the dot to the right. Pressing  key when changing the parameter value will cancel saving operation.
- Setting the value from the range -99999...99999 is similar to the integers.

5.4.3. Programmable transducer parameters

The table below shows programmable parameters and the possible ranges of values.

Table 1

| Settings Input | | | |
|-------------------------|---|-------------------------|------------------------|
| Parameter symbol | Description | Range of changes | |
| Input | Selection of the input type – measured value type | Displayed symbol | Description |
| | | Voltage -10. . 10V | Voltage -10V ... 10V |
| | | Current -24. . 24V | Voltage -24V ... 24V |
| | | Current -20. . 20mA | Current -20mA ... 20mA |
| | | Resi st. 400Ω | Resistance 0 ... 400Ω |
| | | Resi st. 2000Ω | Resistance 0...2000Ω |
| | | Resi st. 5500Ω | Resistance 0...5500Ω |
| | | Pt100 -200. . 850°C | Pt100 -200...850 °C |
| | | Pt250 -200. . 600°C | Pt250 -200...600 °C |
| | | Pt250 -200. . 850°C | Pt250 -200...850 °C |
| | | Pt500 -200. . 180°C | Pt500 -200...180 °C |
| | | Pt500 -200. . 850°C | Pt500 -200...850 °C |
| | | Pt1000 -200. . 250°C | Pt1000 -200...250 °C |
| | | Pt1000 -200. . 850°C | Pt1000 -200...850 °C |
| | | Ni 100 -60. . 180°C | Ni100 -60...180 °C |
| | | Ni 1000 -60. . 150°C | Ni1000 -60...150 °C |
| Ni 100-LG -60. . 180°C | Ni100-LG -60...180 °C | | |
| Ni 1000-LG -60. . 180°C | Ni1000-LG -60...180 °C | | |
| Cu100 50. . 180°C | Cu100 -50...180 °C | | |

| | | | |
|---------|---|--|--|
| | | Vol tage -5. . 20mV | Voltage -5...20mV |
| | | Vol tage -75. . 75mV | Voltage -75...75mV |
| | | Vol tage -200. . 200mV | Voltage -200...200mV |
| | | Therm. J 0. . 400°C | Thermocouple J 0...400°C |
| | | Therm. J -200. . 1200°C | Thermocouple J 200...1200°C |
| | | Therm. K 0. . 400°C | Thermocouple K 0...400°C |
| | | Therm. K -200. . 1370°C | Thermocouple K -200...1370°C |
| | | Therm. S -50. . 1760°C | Thermocouple S 0...1760°C |
| | | Therm. N -20. . 420°C | Thermocouple N -20...420°C |
| | | Therm. N -200. . 1300°C | Thermocouple N -200...1300°C |
| | | Therm. E -40. . 260°C | Thermocouple E -40...260°C |
| | | Therm. E -200. . 1000°C | Thermocouple E -200...1000°C |
| | | Therm. R 0. . 1760°C | Thermocouple R 0...1760°C |
| | | Therm. T -200. . 400°C | Thermocouple T -200...400°C |
| | | Therm. B 400. . 1800°C | Thermocouple B 400...1800°C |
| | | RS-485 | Modbus RS-485 (Master, Slave or Monitor) |
| AvgTime | Averaging time of the measured value [ms] | 75. . 200. . 20000 (from 75 ms only for inputs: Vol tage -10. . 10V, Vol tage -24. . 24V, Current -20. . 20mA) | |

| | | |
|---------------|--|---|
| Com- pens. | Compensation type of : - cold junction temperature for thermocouples - cords resistance for measuring resistance and temperature from thermoresistor sensors | Automat. - Automatic compensation Manual - Manual compensation |
| Comp. Val | Terminal temperature or resistance of cords (depending on the selected type of input) in case of selecting the manual compensation transducer mode | -99999 ... 99999 |
| Median | Number of median filter samples | 1. . . 50 |

| | | | |
|----------|--|--------------|---------------------------------------|
| Math Fun | Mathematical function operation on the input | Off. | Mathematical functions switched off |
| | | $\times 2$ | Square of measured value |
| | | \sqrt{x} | Square root of measured value |
| | | $1/x$ | Inverse of measured value |
| | | $1/x^2$ | Inverse square of measured value |
| | | $1/\sqrt{x}$ | Inverse square root of measured value |

Table 2

| Settings Ind. Char | | |
|-----------------------|--|--------------------|
| Parameter symbol | Description | Range of changes |
| Point No | Number of individual characteristics points for the main input. Number of sections is the number of points minus 1 | 1 . . . 21 |
| X1 | Measured value on the input, for which Yn (n – point number) is expected. | -99999 . . . 99999 |
| Y1 | Expected value for Xn. | -99999 . . . 99999 |

Table 3

| Settings Display | | | | |
|------------------|--|---|----------------|---------------------|
| Parameter symbol | Description | Range of changes | | |
| Decimal P | Minimum decimal point of the displayed value – display format. | 0.0000 - 0 00.000 - 1 000.00 - 2 0000.0 - 3 00000 - 4 | | |
| Unit | Displayed unit | | kVAh | szt |
| | | V | MVAh | imp |
| | | A | Hz | rps |
| | | mV | kHz | m/s |
| | | kV | Ω | l/s |
| | | mA | kΩ | obr/mi |
| | | kA | °C | rpm |
| | | W | °F | mm/min |
| | | kW | K | m/min |
| | | MW | % | l/min |
| | | var | %RH | m ³ /min |
| | | kvar | pH | szt/h |
| | | Mvar | kg | m/h |
| | | VA | bar | km/h |
| | | kVA | m | m ³ /h |
| | | MVA | l | kg/h |
| | | kWh | s | l/h |
| | | MWh | h | User's defined |
| | | kVarh | m ³ | |
| | | MVarh | obr | |

| | | |
|-------------|---|---|
| Over Lo | Lower display range threshold | -99999. . . 99999 |
| Over Hi | Upper display range threshold | -99999. . . 99999 |
| Bckl i ght | Display backlight time | On - always on Off - always off 1 - active for X seconds 2 ... 60 |
| Bckl . I nt | LCD display backlight intensity | 10% - LCD display backlight 10% of maximum backlight 20% - LCD display backlight 20% of maximum backlight ... 100% - LCD display backlight 100% of maximum backlight |
| Di sp. Reg | Number of register displayed at the lower line of the display | 0. . . 65535 |
| Dec. P 2 | Minimum decimal point of the second displayed value | 0. 0000 - 0 00. 000 - 1 000. 00 - 2 0000. 0 - 3 00000 - 4 |
| Uni t 2 | Unit of the second displayed value | Similar to parameter Uni t |

Table 4

| Settings Alarm 1, Alarm 2 | | | |
|------------------------------|---|--------------------|--|
| Parameter symbol | Description | Range of changes | |
| Param. A1 Param. A2 | Input value type for alarm 1 | Di spl Val | displayed value |
| | | Time | time |
| | | 2nd Val | the second displayed value |
| Type A1 Type A2 | Alarm type. Fig.17 shows graphical illustration of the alarm types. | n-on | normal (change from 0 to 1) |
| | | n-off | normal (change from 1 to 0) |
| | | on | switched on |
| | | off | switched off |
| | | h-on | manual, switched on; until the alarm type is changed, the alarm output remains permanently switched on |
| | | h-off | manual, switched off; until the alarm type is changed, the alarm output remains permanently switched off |
| OverLoA1 OverLoA2 | Lower alarm threshold | -99999 . . . 99999 | |
| OverHi A1 OverHi A2 | Upper alarm threshold | -99999 . . . 99999 | |
| DI y0nA1 DI y0nA2 | Alarm activation delay (s) | 0 . . . 900 | |
| DI y0ffA1 DI y0ffA2 | Alarm deactivation delay (s) | 0 . . . 900 | |
| OnLockA1 OnLockA2 | Alarm reactivation delay (s) | 0 . . . 900 | |



| | | | |
|----------------------|-----------------------|-----|---|
| SgKeepA1 SgKeepA2 | Alarm indication mode | Off | alarm occurrence is indicated using LED A1/A2, alarm deactivation switches off LED A1/A2 |
| | | On | alarm occurrence is indicated using LED A1/A2, alarm deactivation causes blinking of A1/A2 LED's until the alarm is reconfigured or cleared with key   combination. |

Table 5

| Settings Output | | | |
|--------------------|--|-------------------|----------------------------|
| Parameter symbol | Description | Range of changes | |
| Param. An | Value which controls analog output | Di spl Val | displayed value |
| | | Ti me | time |
| | | 2nd Val | the second displayed value |
| AnIn Lo | Analog output individual characteristic – lower input threshold | -99999. . . 99999 | |
| AnIn Hi | Analog output individual characteristic – upper input threshold | -99999. . . 99999 | |
| AnOut Lo | Analog output individual characteristic – lower output threshold | -24. . . 24 | |
| AnOut Hi | Analog output individual characteristic – upper output threshold | -24. . . 24 | |

| | | | |
|----------|--|----------------|----------------------------------|
| OvrInLo | Switching on analog output overflow management | Off | Overflow management switched off |
| | | On | Overflow management switched on |
| OvrInLo | Lower input overflow for output overflows | -99999...99999 | |
| OvrInHi | Upper input overflow for output overflows | -99999...99999 | |
| OvrOutLo | Value expected on output on lower overflow | -24...24 | |
| OvrOutHi | Value expected on output on upper overflow | -24...24 | |

Table 6

| Settings Mbus 485 | | | |
|----------------------|---|------------------------------|-------------|
| Parameter symbol | Description | Range of changes | |
| Address | RS-485 MODBUS network address. Enter 0 to switch off the interface, if interface works in Master mode this is the address of requested device | 0...247 | |
| ModeUnit | RS-485 interface transmission mode | r8n2 r8e1 r8o1 r8n1 | |
| BaudRate | RS-485 interface transmission baudrate | 4800 | 4800 bit/s |
| | | 9600 | 9600 bit/s |
| | | 19200 | 19200 bit/s |

| | | | |
|-----------|--|---------------|---|
| | | 38400 | 38400 bit/s |
| | | 57600 | 57600 bit/s |
| | | 115200 | 115200 bit/s |
| | | 230400 | 230400 bit/s |
| | | 256000 | 256000 bit/s |
| Base. Reg | Number of polled / monitored base register in Master or Monitor mode of RS-485 interface | 0 . . . 65536 | |
| No. ofVal | Number of polled values in Master / Monitor mode of RS-485 interface | 0 . . . 50 | |
| Val Type | Type of polled / monitored values in either Master or Monitor RS-485 interface mode | char 8 | char type value (8 bits with sign) |
| | | uchar 8 | unsigned char type value (8 bits without sign) |
| | | short 16 | short type value (16 bits with sign) |
| | | ushort16 | unsigned short type value (16 bits without sign) |
| | | long 32 | long type value (32 bits with sign) |
| | | ulong 32 | unsigned long type value (32 bits without sign) |
| | | fl t 32 | float type value (32 bits, floating point value with sign) |
| | | sfl t2x16 | swapped float type value, 32 bits floating point value placed on two 16-bit registers (Byte order 3,2,1,0) |

| | | | |
|----------|---|----------------------|---|
| | | fl t 2x16 | float type value, 32 bits floating point value placed on two 16-bit registers (Byte order 1,0,3,2) |
| | | l ng 2x16 | long type value (32 bits with sign) placed on two 16-bit registers, (Byte order 1,0,3,2) |
| | | sl ng2x16 | swapped long type value (32 bits with sign) placed on two 16-bit registers, (Byte order 3,2,1,0) |
| | | ul ng2x16 | unsigned long type value (32 bits without sign) placed on two 16-bit registers, (Byte order 1,0,3,2) |
| | | uSl n2x16 | unsigned swapped long type value (32 bits without sign) placed on two 16-bit registers, (Byte order 3,2,1,0) |
| Interv. | Polling interval in Master RS-485 mode | 1 . . . 36000 [0.1s] | |
| AnswTime | The maximal response time of the device working in Master or Monitor RS-485 interface mode [ms] | 10 . . . 5000 [ms] | |

| | | | |
|-----------|--|------------|---|
| Mode | RS-485 interface working mode | Slave | RS-485 interface works in Modbus Slave mode, transducer waits for requests and responds on request addressed to its address |
| | | Monitor | Transducer monitors traffic on RS-485 interface and acts on data other devices transmit |
| | | Master | RS-485 interface works in modbus Master mode, transducer sends requests and waits for reply from Slave device |
| Mast. Fun | Selection of modbus Master function | fun. 0x03 | Function 0x03 |
| | | fun. 0x04 | Function 0x04 |
| No. OfErr | Number of acceptable errors in modbus RS-485 answers when transducers interface works in Master mode | 0 . . . 10 | |

Table 7

| Settings Archive | | | |
|---------------------|--|--------------------|---|
| Parameter symbol | Description | Range of changes | |
| Arch. Val | Selection of archived values Note: <i>changing the register value clears the archive in the internal memory!!!</i> | Di spl Val | only displayed value |
| | | +2nd Val | displayed value and the second displayed value |
| | | +Quer i ed | displayed value, second displayed value and all queried values using RS-485 interface |
| Param. Ar | Type of input value which controls conditional archiving | Di spl Val | displayed value |
| | | Ti me | time |
| | | +2nd Val | second displayed value |
| Ar. Mode | Archiving triggering condition fig. 25 shows a visualization of condition types triggering archiving (similarly to alarm types). | n-on | normal (change from 0 to 1) |
| | | n-off | normal (change from 1 to 0) |
| | | on | switched on |
| | | off | switched off |
| | | h_on | manual, switched on; until the archiving type is changed, the archiving remains permanently switched on |
| | | h_off | manual, switched off; until the archiving type is changed, the archiving remains permanently switched off |
| OverLoAr | Archive lower threshold | -99999 . . . 99999 | |
| OverHi Ar | Archive upper threshold | -99999 . . . 99999 | |
| Ar. Ti me | Archiving period (s) | 1 . . . 3600 | |

| | | | |
|-----------|---|----------|--------------------------------|
| Ar. Erase | Erasing internal archive | Yes | Start erasing internal archive |
| | | No | Without changes |
| Rec. ToSD | Copy internal archive into SD/SDHC card (variant P30U-X1XXXXXX) or into internal file system memory (variant P30U-X2XXXXXX) | Yes | Start copying the archive |
| | | No | Without changes |
| Param. SD | Percent of internal archive use which triggers automatic copying to SD/SDHC card | 5 ... 95 | |

Table 8

| Settings Ethernet (option, only variant P30U-X2XXXXXX) | | | |
|---|--|------------------|---|
| Parameter symbol | Description | Range of changes | |
| DHCP | Switching DHCP client on/off (enables automatic transducer configuration which is connected to a network so it can communicate on that network using the Internet Protocol IP) | Off | DHCP switched off – manually configure transducer's IP address and subnet mask; |
| | | On | DHCP switched on, after powering on or selecting from menu option <code>ReInitEt</code> the transducer will receive IP address, subnet mask and gateway address from the DHCP server, the gateway address will be the address of the server that assigned parameters to the transducer; |

| | | |
|----------|---|---------------------|
| addrIP32 | Third and second byte (B3.B2) of transducer's IP address, value displayed in a decimal format, IPv4 address format: B3.B2.B1.B0 | 000.000 ... 255.255 |
| addrIP10 | First and zero byte (B1.B0) of transducer's IP address, value displayed in a decimal format, IPv4 address format: B3.B2.B1.B0 | 000.000 ... 255.255 |
| mask 32 | Third and second byte (B3.B2) of transducer's subnet mask, value displayed in decimal format, mask format: B3.B2.B1.B0 | 000.000 ... 255.255 |
| mask 10 | First and zero byte (B1.B0) of transducer's subnet mask, value displayed in a decimal format, mask format: B3.B2.B1.B0 | 000.000 ... 255.255 |
| gate 32 | Third and second byte (B3.B2) of transducer's default gateway, value displayed in a decimal format, gateway address format: B3.B2.B1.B0 | 000.000 ... 255.255 |
| gate 10 | First and zero byte (B1.B0) of transducer's default gateway, value displayed in a decimal format, gateway address format: B3.B2.B1.B0 | 000.000 ... 255.255 |
| MAC 54 | Fifth and fourth byte (B5.B4) of transducer's MAC address, value displayed in a decimal format; format B5:B4:B3:B2:B1:B0 | 000.000 ... 255.255 |
| MAC 32 | Third and second byte (B3.B2) of transducer's MAC address, value displayed in a decimal format; format B5:B4:B3:B2:B1:B0 | 000.000 ... 255.255 |

| | | | |
|------------|---|-----------------------|--|
| MAC 10 | First and zero byte (B1. B0) of transducer's MAC address, value displayed in a decimal format; format B5:B4:B3:B2:B1:B0 | 000. 000 ... 255. 255 | |
| AddrmTCP | Device address for Modbus TCP/IP protocol | 0 ... 255 | |
| PortMbus | Modbus TCP/IP port number | 0 ... 65535 | |
| TimeMbus | Modbus TCP/IP service port closing time, the value is given in seconds | 10 ... 600 | |
| no. c. TCP | Maximum number of simultaneous connections with Modbus TCP/IP service | 1 ... 4 | |
| p. comFTP | FTP server command port number | 20. . . 65535 | |
| Port FTP | FTP server data port number | 20. . . 65535 | |
| Port HTTP | HTTP server port number | 80. . . 65535 | |
| LnkSpeed | Transmission rate | Auto | automatic |
| | | 10 Mb/s | 10 Mbit/s |
| | | 100 Mb/s | 100 Mbit/s |
| EthStdPa | Set default Ethernet interface parameters | Yes | restore default Ethernet interface parameters |
| | | No | without changes |
| Relni tEt | Apply a new Ethernet interface parameters | Yes | save a new Ethernet interface parameters and reinitiate the Ethernet interface |
| | | No | without changes |

Table 9

| Settings Service | | | |
|------------------|--|---------------------|-----------------------------|
| Parameter symbol | Description | Range of changes | |
| Fabr. Par | Restore factory parameters. Choose Yes to write standard parameters to the transducer. Factory parameters are shown in table 17. | No | without changes |
| | | Yes | restores factory parameters |
| Securi ty | Enter new password. Enter "0" to deactivate password. | -99999...99999 | |
| Time | Set current time. Setting incorrect time cancels time setting - the entered value will not be taken. | 00:00...23:59 | |
| Date | Set current date: month + day. Setting incorrect date cancels data setting - the entered value will not be taken. | 01-01-10...31-12-99 | |
| AutoTime | Auto change of summer/winter time and vice versa | No | without auto time change |
| | | Yes | with auto time change |
| Di spTest | LCD display and indicating LED's test | No | do nothing |
| | | Yes | starts the test |
| Language | Select current menu language | Pol ski | select Polish language |
| | | Engl i sh | select English language |
| | | Deutsch | select German language |
| | | Francai s | select French language |

| | | |
|----------|-----|--|
| SaveFile | No | do nothing |
| | Yes | Force writing transducer configuration file into an external SD/SDHC card or internal file system memory |

5.5. Transducer functions

5.5.1. Measurement input

The P30U transducer is equipped with universal, configurable measurement input, which enables to measure direct current, direct voltage, resistance and temperature from thermocouples and thermistors. Detailed information about supported inputs is shown in table 48. Input type RS-485 is a special type of input, in which transducer treats value from register 8000 as a measured value. Value in register 8000 depends on RS-485 interface working mode (Slave, Monitor or Master) and can be written, monitored or read via RS-485 interface.

5.5.1.1. Interface RS-485 Master mode

RS-485 interface can work in Master mode, in which device is able to read data registers from one slave device connected to transducer. Both devices must have the same communication parameters. The RS-485 Master mode is switched on by selecting the appropriate mode of RS-485 interface from menu: Mbus 485 → Mode →

Master or by entering value „2” into the register 4042. In the Master mode the following parameters should be configured in the Mbus 485 menu:

Table 10

| Item | Mbus 485 | |
|------|-----------|---|
| 1 | Address | Address of the device being read out |
| 2 | ModeUnit | Transmission mode on the connection |
| 3 | BaudRate | Baud rate |
| 4 | Base. Reg | Number of the first read out register |
| 5 | No. ofVal | Number of read out values |
| 6 | Val Type | Type of read out values |
| 7 | Interv. | Read out interval [x100 ms] |
| 8 | AnswTime | Maximal response time [ms] |
| 9 | Mode | Working mode of RS-485 interface |
| 10 | Mast. Fun | Kind of used master function(0x03 or 0x04) |
| 11 | No. OfErr | Admissible number of incorrect responses to the transducer request (number of repeated requests before an error is displayed) |

The parameters (4 - 6) may also be configured by RS-485 (registers 4048- 4052) before the RS-485 Master mode is selected. After selecting the RS-485 Master mode it is impossible for other Master device to poll the transducer.

All values read in Master mode are available as a floating point values in registers from range 8000...8049., first read out value is placed in register 8000, second value in 8001 register etc. In the transducer Mbus 485 menu there is the parameter No. ofErr, which defines the admissible number of incorrect responses to the transducer request (number of repeated requests before an error is displayed). That parameter is also modified by RS-485 (register 4005) before the RS-485 Master mode is selected. If input type Input → RS-485 is selected, the first register being polled is

treated as the measured value (register 8000). If the request refers to a larger number of registers (parameter No. ofVal > 1), then it is possible to display, at the bottom row of the display, the value of other register than the first one being polled, because all the polled registers are copied to the block of registers from the range 8000...8049. For example, when we want to display additionally the value of the second register being polled, we should set the value "8001" in the menu of the parameter Display → Display Reg. (the first value being polled is in the register 8000 and it is treated as the main displayed value) or enter the value "8001" into the register 4024.

In order to make the transducer RS-485 interface work again in the Slave mode, one should select proper mode in menu RS-485 Mbus 485 → Mode → Slave.

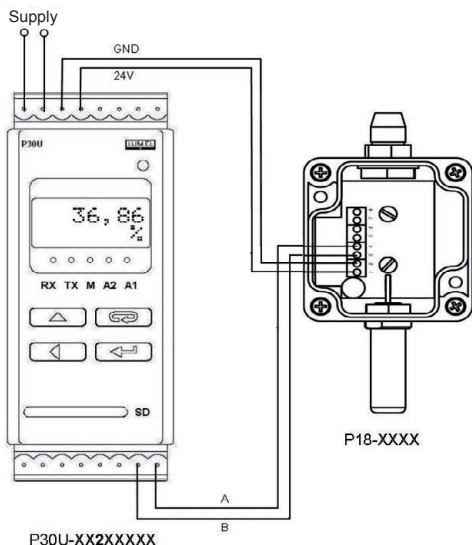

Fig.9. Example of using a P30U transducer in the RS-485 Master mode to read and register relative humidity from a P18 transducer.

5.5.1.2. Interface RS-485 Monitor mode

RS-485 interface can work in Monitor mode, in which device is able to listen to traffic in the RS-485 network and react to specific register of responses of the selected device. The P30U transducer must have the same communication parameters as the device being listened to. The RS-485 Monitor mode is switched on by selecting the appropriate mode from menu: Mbus 485 → Mode → Monitor or by entering the value "1" into the register 4042. In the RS-485 Monitor mode the following parameters should be configured in the Mbus 485 menu:

Table 11

| Item | Modbus | |
|------|-----------|--|
| 1 | Address | Address of the device being listened to |
| 2 | ModeUnit | Transmission mode on the connection |
| 3 | BaudRate | Baud rate |
| 4 | Base. Reg | Base monitored register number |
| 5 | Val Type | Type of read out values |
| 6 | AnswTime | Maximal time of reply of the device being listened to [ms] |

The parameters (4 - 6) may also be configured by RS-485 (registers 4048- 4052) before the RS-485 Monitor mode is selected. After selecting the RS-485 Monitor mode it is impossible for other Master device to poll the transducer.

Similarly as in the RS-485 Master mode the registers being listened to are copied to the register area from the range 8000...8049. The first register being listened to is copied to the register 8000 and it can be treated as the main displayed value. If the parameter No. ofVal > 1, then the values of the following registers being listened to reach the following registers from the range 8000...8049. For example, when we want to display additionally the value of the third register being listened to,

we should set the value “8002” in the menu of the parameter Display → Di sp. Reg. or enter the value “8002” into the register 4024.

In order to make the transducer RS-485 interface work again in the Slave mode, one should select proper mode in menu RS-485 Mbus 485 → Mode → Slave.

5.5.1.3. Median filter

Median filter function on measured value is implemented in Transducer P30U. This function enables to filter input signal from influence of perturbances on input signal. Parameter Input → Median specifies number of samples from which signal will be filtered - number of samples determines filtering period. For example, if transducer is configured for measuring voltage from 0...10 V range (sample rate 80 ms) , median function is off and sequential measured samples are: 10.0065, 10.0055, 10.025, 10.004, 10.0055, then the output value will be unstable and average value will have value 10.0093. Average value does not describe the real level of considered signal what is shown on fig. 10.

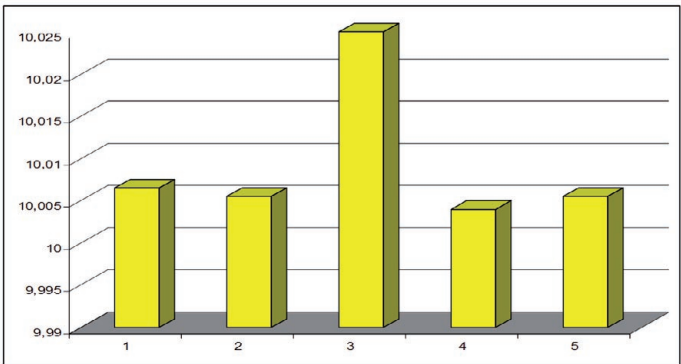

Fig.10. Exemplary signal – samples unsorted

After switching median filter on with number of samples 5 (sample rate 80 ms) 5 subsequent samples will be sorted and only median sample will be treated as measured value (sample no 3 after sorting). After sorting X_n values are as follows: 10.004, 10.0055, 10.0055, 10.0065, 10.025.

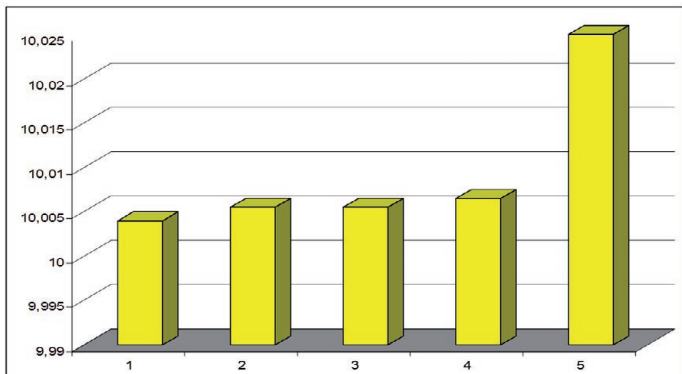

Fig.11. Median filter operation – sorted samples





Value $X_3 = 10.0055V$ will be treated as a result of median operation in this example. Average value after switching the median filter on will also have value $X_3 = 10.0055V$. The highest value of perturbations on measured signals the highest number of median samples should be applied from range 1...50. If number of median samples is set to „1” median operation is switch off. If an even number of samples is chosen, average of two median values will be given as a result of median operation.

5.5.1.4. Averaging time

Various averaging time of the measured value can be defined in transducer P30U. Averaging time of measured value can be set within 0.075...0,2...20 s range – the moving window averaging function has been used. The minimal time below 0,2 s can only be used for input types: Vol tage -10. . 10V, Vol tage -24. . 24V, Current -20. . 20mA.

5.5.1.5. Maximum and minimum values of measured signals

The P30U transducer has been fitted with the function of storing minimum and maximum value with the time and date of occurrence. Minimum and maximum value are stored after a power supply loss, they can be read and reset using transducer registers via Modbus protocol (RS-485, TCP/IP – see table 37, WWW server, they can also be displayed on the display using the following keys:

 - the maximum value,  - the minimum value. Erasing the minimum and maximum value is possible via keypad after pressing the combination of  and .

5.5.1.6. Mathematical operations on measured values

The transducer enables the performance of additional mathematical operations on the measured value. The following mathematical operations have been implemented in the transducer:

- mathematical functions,
- 21-point individual characteristic,
- display range limit (main input only).

The way in which the mathematical operation influences the measured value is shown at fig. 12. Switching on and selection of the mathematical operation is possible via the keypad, Modbus protocol (RS-485, TCP/IP) and WWW server.

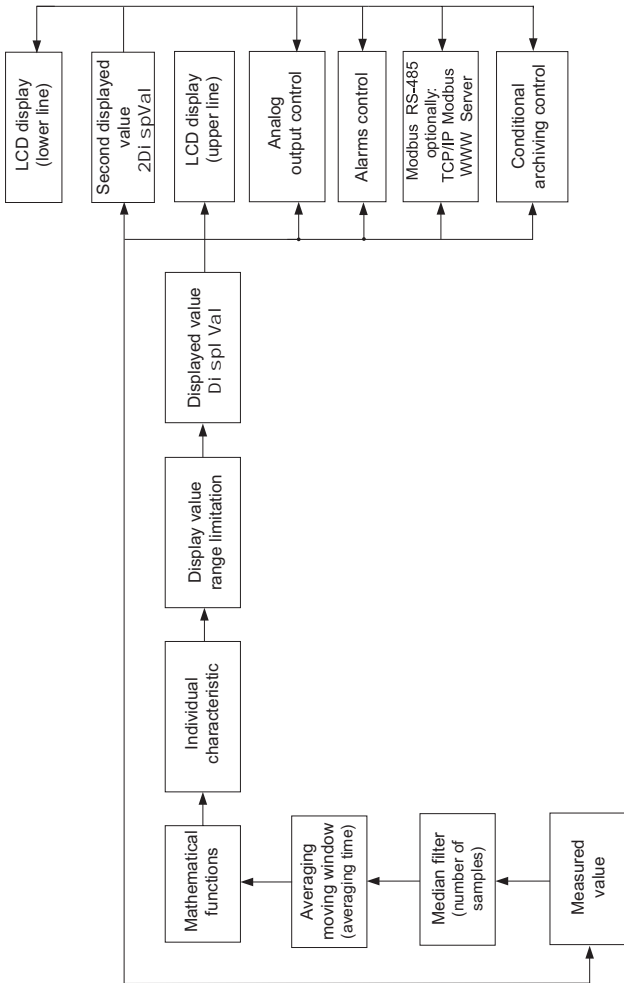

Fig.12. The way in which the mathematical operations influence the measured value

5.5.1.7. Mathematical functions

The P30U transducer can calculate the measured values using one of 5 implemented mathematical functions:

- square of measured value,
- root of measured value,
- inverse of measured value,
- inverse square of measured value,
- inverse root of measured value.

The operation of mathematical functions is switched off by default.

5.5.1.8. Input individual characteristic

P30U transducers perform the function of conversion of the measured value to any value due to implemented function of individual characteristics of the input. Independent individual characteristics have been implemented for the main input and the auxiliary input. The individual characteristics rescales the input signal being measured according to the characteristics set. The user can enter a maximum of twenty functions each by specifying points determining the ranges and expected values for subsequent points.

Programming individual characteristic consists in the definition of the number of points which the input function will be linearized by. Note that the number of linearized functions is the number of points minus one. Next, one must program subsequent points by providing the measured value X_n and the expected value corresponding to it – the value to be displayed (Y_n). The visual interpretation of the individual characteristic is shown on fig. 13.

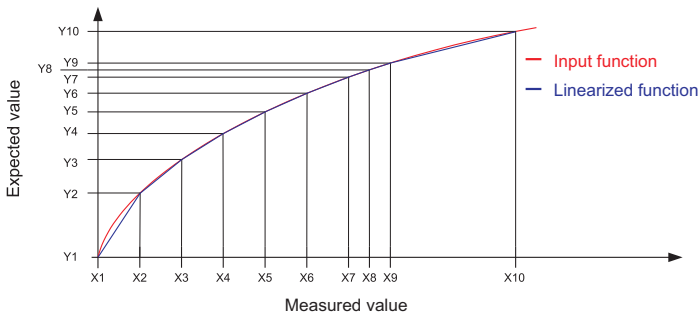

Fig.13. Input individual characteristic

During function approximation, one must remember that in the case of approximating curves that significantly deviate from linear characteristics, the higher number of linearising sections, the lower the linearisation error.

If the measured values are lower than X_1 , then the calculations will be made based on the first straight line calculated based on points (X_1, Y_1) and (X_2, Y_2) . However, for values higher than X_n (where n – the last declared measured value), the displayed value will be calculated based on the linear function determined last.

Note: All the entered points of the measured value (Y_n) must be arranged in ascending order, so that the following dependence is true:

$$X_1 < X_2 < X_3 \dots < X_n$$

If the dependence specified above is not true, the individual characteristic functions will be automatically switched off (will not be performed) and a diagnostic flag will be set in the status register. Individual characteristics are switched off by default. Parameters of individual characteristics can be configured via keyboard as separate groups of sub-menu: I nd. Char.

5.5.1.9. Displayed value range limitation

The value range limitation applies only to the main input, so that it influence only the displayed value *Di spl Val* . The value range limitation parameters are located in the menu in the group of *Di spl ay* parameters: *Over Lo* – lower display value threshold and *Over Hi* – upper display value threshold. The default value of upper overflow is 99999 , and for lower overflow -99999. If the lower display overflow occurs the *vvvvvv* , symbol is displayed on the display and the number value of the displayed value is set to -1e20. If the upper display overflow occurs the *oooooooo* symbol is displayed on the display and the number value of the displayed value is set to +1e20.

5.5.2. Analog output

The P30U transducer is equipped with one current type (source) or voltage type analog output depending on the variant code.

5.5.2.1. Analog output individual characteristic

The P30U transducer enables processing displayed value, second displayed value and the real time clock value into analog output signal based on the individual linear characteristic of the analog output. On the basis of coordinates of two points provided by the user, the transducer determines (using a system of equations) a and b individual characteristic coefficients.

$$\begin{cases} Y1out = a \cdot X1in + b \\ Y2out = a \cdot X2in + b \end{cases}$$

where *X1 in* and *X2 in* – the displayed value,
Y1 out and *Y2 out* – expected value on the analog output.

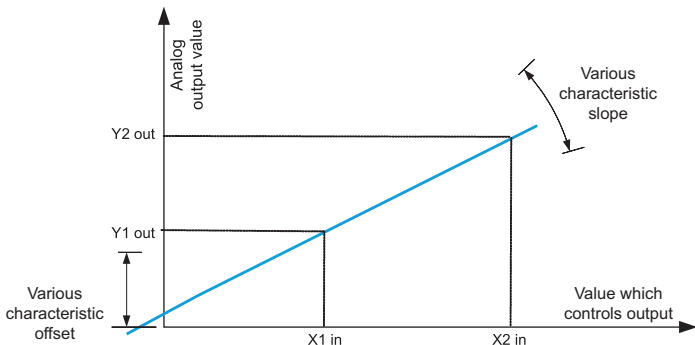

Fig.14. Analog output individual characteristic

5.5.2.2. Analog output overflow management

In P30U transducer user can additionally configure the behaviour of the analog output after controlling output value overflow. By default, overflow management is switched off – in such a case, after controlling output value is overflowed, the output is still controlled proportionally to the controlling output value outside the basic range of the output. After the overflow management is switched on, the user can define the value to control the output after the occurrence of the upper or lower overflow of the controlling output value.

Example 1: Analog output configuration

The transducer set to measure temperature from thermocouple J – Input: Therm. J -200. . 1200°C. Individual characteristic of the current type analog output set as follows:

Table 12

| Register no. | Parameter symbol in the menu | Register value | Parameter value symbol in the menu |
|--------------|------------------------------|----------------|------------------------------------|
| 4040 | Param. An | 0 | Di spl Val |
| 4041 | OverServ | 0 | Off |
| 7610 | AnI n Lo | 0 | 0. 0 |
| 7611 | AnI n Hi | 1000 | 1000. 0 |
| 7612 | AnOut Lo | 4 | 4 |
| 7613 | AnOut Hi | 20 | 20. 0 |

Fig. 15 shows the reaction of the analog output when analog output overflow management is switched off – standard operation of the analog output.

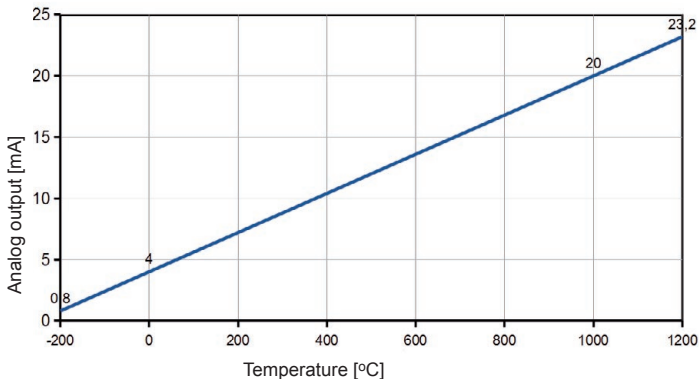

Fig.15. Operation of the analog output when overflow management is switched off

If in the same case the analog output overflow management is switched on (parameters set according to table 13), the reaction of the analog output will be as is shown on fig. 16.

Table 13

| Register no. | Parameter symbol in the menu | Register value | Parameter value symbol in the menu |
|--------------|------------------------------|----------------|------------------------------------|
| 4040 | Param. An | 0 | Di spl Val |
| 4041 | OverServ | 1 | On |
| 7610 | AnI n Lo | 0 | 0. 0 |
| 7611 | AnI n Hi | 1000 | 1000. 0 |
| 7612 | AnOut Lo | 4 | 4 |
| 7613 | AnOut Hi | 20 | 20. 0 |
| 7664 | OvrI n Lo | 0 | 0 |
| 7665 | OvrI n Hi | 1000 | 1000 |
| 7666 | OvrOutLo | 1,5 | 1, 5 |
| 7667 | OvrOutHi | 3,5 | 3, 5 |

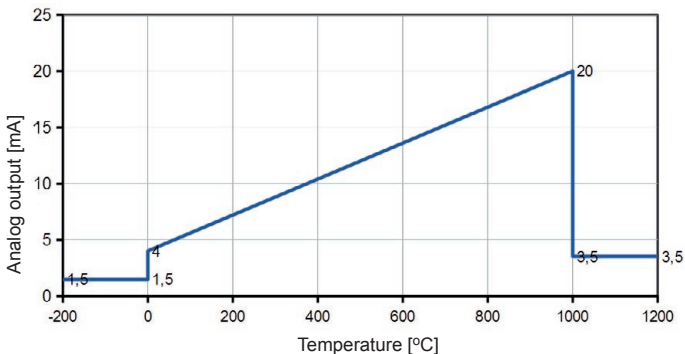

Fig.16. Operation of the analog output when overflow management is switched on

Example 2: Configuration of the analog output controlled by real time clock

The transducer set to measure temperature from Thermocouple J: Therm. J 0...400°C. The individual characteristic of the current type analog output is set, that the output reacts to current time (hour, minute), i.e. for 00:00 o'clock expected value is 4 mA, for 23:59 o'clock expected value is 20 mA:

Table 14

| Register no. | Parameter symbol in the menu | Register value | Parameter value symbol in the menu |
|--------------|------------------------------|----------------|------------------------------------|
| 4040 | Param. An | 0 | Time |
| 4041 | OverServ | 1 | Off |
| 7610 | AnIn Lo | 0 | 0.0 |
| 7611 | AnIn Hi | 23.59 | 23.59 |
| 7612 | AnOut Lo | 4 | 4 |
| 7613 | AnOut Hi | 20 | 20.0 |

5.5.3. Alarm and power outputs

The P30U transducer is equipped with 2 relay alarm outputs with a normally open contact or with 1 relay output with a normally open contact and 1 power supply output 24 V d.c. (depending on the manufacturing variant code). Each alarm (power supply output 24 V d.c. should be treated similarly to the alarm) can operate in one of six modes. Fig. 17 shows alarm operation in the following modes: n-on, n-off, on, off. Two remaining modes: h-on i h-off mean, respectively, always on and always off. These modes are intended for manual simulation of alarm states.

In case of the transducer variant with 24 V d.c. output, the second alarm mode should be set to h-on, in such a case, the auxiliary power supply output will be constantly switched on.

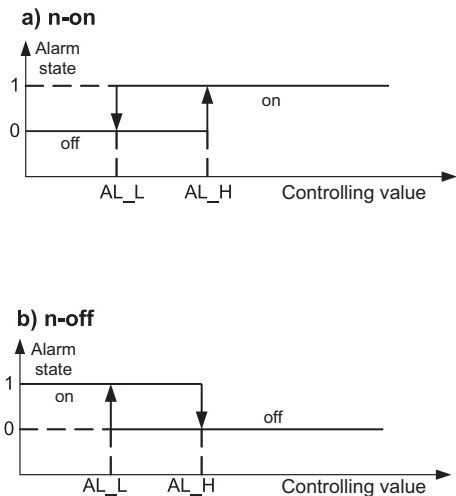

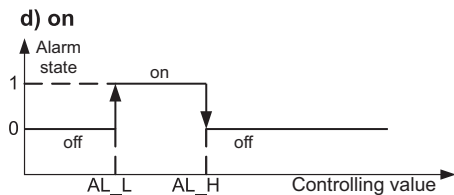
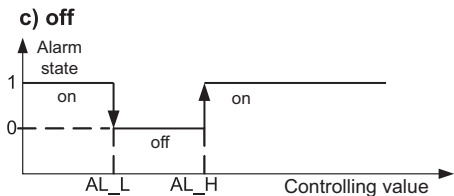

Fig.17. Alarm types: a) n-on; b) n-off; c) on; d) off.

AL_L - Lower alarm threshold
 AL_H – Upper alarm threshold

Note: If alarms are n-on, n-off, on, off type, entering $AL_L > AL_H$ will switch off the alarm.

5.5.4. LCD display

The P30U transducers are equipped with a backlit LCD display consist of two lines of 8 characters each. The top line of the display is used for presenting the displayed value in floating point format (5 digits) and for displaying the SD/SDHC card or internal file system memory status pictograms, or maximum or minimum value pictograms after pressing







 or  keys.



Table 15



| Symbol | Method of display | Meaning |
|--|-------------------|--|
|  | constant | SD/SDHC card or internal file system memory mounted and ready to operate |
| | blinking | SD/SDHC card unmounted and ready for removing |
|  | blinking | SD/SDHC card is protected against writing |
|  | blinking | SD/SDHC card or internal file system memory is full |
|  | constant | Displays the maximum value of displayed value (value measured and counted from main input) |
|  | constant | Displays the minimum value of displayed value (value measured and counted from main input) |

The P30U transducer automatically adjust the format (accuracy) of display to the displayed value. To fully use the function, go to menu and select **Settings Display** → **Decimal P** → **0.0000** or enter “0” in register 4021, then the transducer will display the displayed value with as much accuracy as possible. Note that a higher resolution display is not always helpful, because it may lead to a decreased stability of indications.

Measurement range overflows are indicated by displaying special signs at the upper line of the LCD display:

- vvvvvv - lower overflow of the input signal range
- ^^^^^^ - upper overflow of the input signal range

The lower line of the P30U transducer display is multi-functional. Press  or  key to cycle through the functions of the bottom row of the display:

- unit (selected from the defined units or custom (section 5.4.3, table 3) with the indication of internal memory use  (pkt 5.8.2, table 18.)
- time in HH:MM:SS format
- date in DD:MM:YY format
- bar graph showing percent control of the analog output
- the second displayed value  - value of any transducer's register as a floating point number – the number of register to be displayed should be entered in register 4024 (to display the float type register value located in 16 bit registers, e.g. 7000 register, enter the number of 32 bit register corresponding to it → 7500).

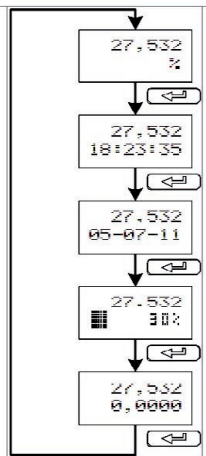

Fig.18. Diagram of switching information displayed in the lower line of the display.

The function selected for the bottom row of the display is stored even after a power loss. LCD display can also show service information about the status of the transducer – see table 16.

Table 16

| Message | Description |
|----------------------|--|
| Restore Fabr. Par | Factory parameters must be set, e.g. following software update, transducer can operate – restore factory parameters; the message does not prevent the measured values from being displayed, it is displayed in cycles. |
| Fabr. Par done | Successfully restored transducer factory parameters, the transducer can operate, the message does not prevent the measured values from being displayed, it is displayed in cycles for 20 seconds. |
| IP renew DHCP : | Successfully refresh ethernet communication data from DHCP server; after this information achieved IP address is displayed on LCD display (only for variants equipped with Ethernet interface) |

5.5.4.1. Custom unit definition

In the transducers of the P30 family, apart from the defined standard units, it is possible to define user own unit to be displayed in the lower line of the LCD display. The maximum size of the unit field is 5 characters, each character consists of 8 lines which makes $5 \times 8 = 40$ fields (registers) that define the unit. Custom unit has been defined in the transducers by default - the LUMEL logo. In order to display the custom unit, enter "57" in register 4020 or select the unit from the transducer menu.

To define a custom unit, use registers from 4400 ... 4440 range. The following figure presents the method of defining the unit.

| | | | | | | |
|------------------|--|--|--|--|--|--|
| Character line 1 | | | | | | |
| | | | | | | |
| | | | | | | |
| | | | | | | |
| | | | | | | |
| | | | | | | |
| | | | | | | |
| Character line 8 | | | | | | |

Fig.19. Field intended for the unit at the lower line of the LCD display.

| Register | Value | n character | | | | |
|--------------|-------|-------------|---|---|---|---|
| 4400+(n-1)*8 | 0x1F | 1 | 1 | 1 | 1 | 1 |
| 4401+(n-1)*8 | 0x10 | 1 | | | | |
| 4402+(n-1)*8 | 0x14 | 1 | | 1 | | |
| 4403+(n-1)*8 | 0x14 | 1 | | 1 | | |
| 4404+(n-1)*8 | 0x14 | 1 | | 1 | | |
| 4405+(n-1)*8 | 0x17 | 1 | | 1 | 1 | 1 |
| 4406+(n-1)*8 | 0x10 | 1 | | | | |
| 4407+(n-1)*8 | 0x1F | 1 | 1 | 1 | 1 | 1 |

Fig.20. Method of coding a custom unit in a single display field.

5.5.4.2. Displaying two values with their units

P30U transducer enables displaying two different values with their units - displayed value at the top row of display and the second displayed value (value of any transducer register) at the bottom row of the display. It is possible to display both values with their units. The displayed value unit is chosen from menu *Settings* → *Display* → *Unit* (register 4020), and the second displayed value unit is chosen from menu *Settings* → *Display* → *Unit 2* (register 4023). Displaying two units is only possible when on the bottom row of display is displayed second displayed value marked with  sign.

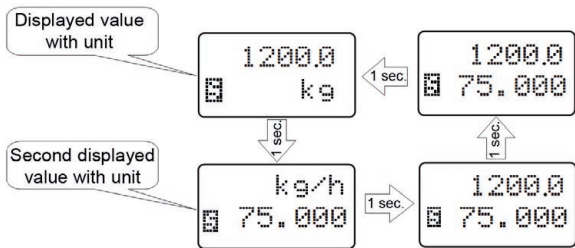

Fig.19. Algorithm of displaying two values with their units

5.5.5. Writing and reading transducer configuration from file

P30U-X1XXXXXX and P30U-X2XXXXXX manufacturing variants of P30U transducers enable storing and reading configuration from the file located on an external SD/SDHC card or in the internal file system memory.

5.5.5.1. Storing the transducer configuration file

To store the current transducer configuration, select option: Service → SaveFile → Yes, from the menu or enter “1” in register 4077. The text file with configuration will be saved to **P30U**, folder, file name: **P30U_PAR.CON** (section 5.8.4. Fig. 27.). Any subsequent saving the configuration file will overwrite the current file.

5.5.5.2. Reading the transducer configuration file

Reading the transducer configuration from file enables quick configuration of the transducer equipped with an external SD/SDHC card or internal file system memory. The configuration file should be located in **P30U** folder and its name should be **P30U_PAR.CON**. The file can be generated by a properly configured P30U transducer or by eCon software (Modbus RS-485 or TCP/IP). In case of transducers in P30U-X2XXXXXX manufacturing variant, the file

can be moved from one device to another using the FTP protocol. In case of P30U-X1XXXXXX manufacturing variants, a single external memory card can be used to transfer configuration to multiple transducers equipped with external SD card slots.

To force parameter update from file, switch on the transducer while pressing  key. If the configuration file contains appropriate data and the new configuration is accepted, the following message will be displayed on the transducer display:

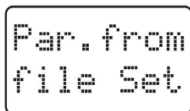

Par. from
file Set

Fig.22. Message confirming successful readout transducer configuration from file.

If the parameter update from file is forced and a proper file is missing or existing file contains corrupted data (at least one corrupted parameter), the current configuration will be maintained and the following message will be displayed:

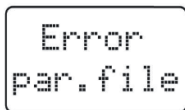

Error
par. file

Fig.23. Message informing about an unsuccessful readout transducer configuration file.

5.6. Default settings

Default P30U transducer settings have been provided in table 17. These settings can be restored using transducer menu by selecting Settings Service → Fabr. Par → Yes or via RS-485 interface by entering “1” in register 4055.

Table 17

| | Parameter symbol | Standard value |
|------------|-------------------------|-----------------------|
| I nput | I nput | Therm. J 0. . 400°C |
| | AvgTi me | 1000 |
| | Compens. | Automat. |
| | Comp. Val | 0 |
| | Medi an | 3 |
| | Math Fun | Off. . |
| I nd. Char | Poi nt No | Off |
| | X1 | 0, 0000 |
| | Y1 | 0, 0000 |
| | . . . | |
| | Xn | (n-1)*100 |
| | Yn | (n-1)*100 |
| Di spl ay | Deci mal P | 0. 0000 |
| | Uni t | s |
| | Over Lo | -99999 |
| | Over Hi | 99999 |
| | Bckl i ght | On |
| | Bckl . I nt | 70, 00% |
| | Di sp. Reg | 7515 |
| | Dec. P 2 | 0. 0000 |
| | Deci mal P | 0. 0000 |

| | | | |
|-------------|-------------|------------|------------|
| Al arm 1, 2 | Param. A1 | Param. A2 | Di spl Val |
| | Type A1 | Type A2 | n-on |
| | OverLoA1 | OverLoA2 | 0 |
| | OverHi A2 | OverHi A2 | 20 |
| | DI y0nA1 | DI y0nA2 | 0 |
| | DI y0ffA1 | DI y0ffA2 | 0 |
| | OnLockA1 | OnLockA2 | 0 |
| | SgKeepA1 | SgKeepA2 | On |
| Output | Param. An | Di spl Val | |
| | AnI n Lo | 0 | |
| | AnI n Hi | 100 | |
| | AnOut Lo | 0 | |
| | AnOut Hi | 20 | |
| | OverServ | Off | |
| | OvrI n Lo | 0 | |
| | OvrI n Hi | 20 | |
| | OvrOutLo | 0 | |
| | OvrOutHi | 0 | |
| Mbus 485 | Address | 1 | |
| | ModeUni t | r8n2 | |
| | BaudRate | 9600 | |
| | Base. Reg | 7510 | |
| | No. ofVal | 1 | |
| | Val Type | fl t 32 | |
| | I nterv. | 10 | |
| | Answ. Ti me | 1000 | |
| | Mode | SI ave | |

| | | |
|-----------|-----------|--|
| | Mast. fun | 0x03 |
| | No. ofErr | 2 |
| Archive | Arch. Val | Di spl Val |
| | Param. Ar | Di spl Val |
| | Ar. Mode | h-off |
| | OverLoAr | 0, 0000 |
| | OverHi Ar | 0, 0000 |
| | Ti me Ar | 10 |
| | Ar. Erase | No |
| | Rec. ToSD | No |
| | Param. SD | 50, 000 |
| | Service | Fabr. Par |
| Securi ty | | 00000 |
| Ti me | | undefined |
| Date | | undefined |
| AutoTi me | | No |
| Di spTest | | No |
| Language | | Pol ski (P30U-XXXXXXPX variants) Engl i sh (P30U-XXXXXXEX variants) |
| SaveFi le | | No |

| | | |
|-------------------|------------|---|
| Ethernet (option) | DHCP | On |
| | addrIP32 | 192. 168 |
| | addrIP10 | 001. 030 |
| | mask 32 | 255. 255 |
| | mask 10 | 255. 000 |
| | gate 32 | 192. 168 |
| | gate 10 | 001. 001 |
| | MAC 54 | Various value – specific to each transducer |
| | MAC 32 | |
| | MAC 10 | |
| | AddrmTCP | 1 |
| | PortMbus | 502 |
| | TimeMbus | 60 |
| | no. c. TCP | 4 |
| | p. comFTP | 21 |
| | Port FTP | 1025 |
| | PortHTTP | 80 |
| | LnkSpeed | Auto |
| | EthStdPa | No |
| Rel ni tEt | No | |

5.7. Firmware update

P30U transducer enables firmware update by user using PC computer with eCon software installed. The free eCon software and update files are available at www.lumel.com.pl. RS-485 to USB converter, e.g. PD10 converter, is required for proceeding with the update.

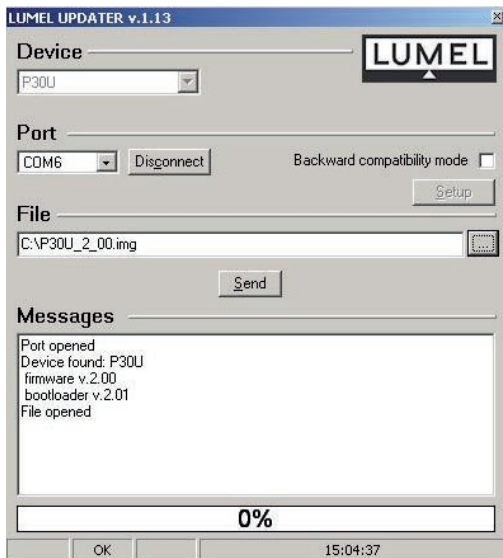



Fig.24. Screenshot of the software for updating transducer firmware.

Note! After firmware update, default transducer settings must be set, therefore it is recommended to store the transducer parameters before starting the update process using eCon software



After starting eCon software, set the rate, mode and transducer address, as well as the RS-485 interface port in **Communication** tab. Next, click **connect** icon and read all transducer parameters (required for restoring them later). Then, click **Update firmware** link which will call LUMEL UPDATER (LU) software dialog – fig. 24. Check transmission parameters using **Setup** button and press **Connect** button. Information about the update progress are displayed in Messages box. If the port is correctly opened, **Port opened** information is displayed. There are two methods of entering updating mode in the transducer: remotely via LU (based on eCon settings – address, mode, rate, COM port) or by powering the transducer on while holding down  key – update using default communication parameters, i.e. rate 9600 kb/s, mode 8N2, or while holding down  - key - update using recommended communication parameters, i.e. rate 115200 kb/s, mode 8N2. If all indicating LEDs are on and the display shows Connect UPDATER message, transducer is ready to connect with computer. If the transducer establishes communication with LUMEL UPDATER (LU) software, **Device found: P30U** message and the version of the main firmware and bootloader will be displayed, as well as the **Device is ready** message will be shown on the transducer display. Next, press “...” button and read the file with the new firmware version in LUMEL UPDATER. If the file opens properly, **File opened** information will be shown in the LU software window. Press Send button. During the update process, the indicating LEDs are switched on in a sequence, and the percent progress of update is shown on the lower line of the display. After a successful update, the transducer restarts to normal operation, whereas **Done** message and update duration are displayed in the information box (LU).

The current firmware version can also be checked by reading the welcome messages of the transducer after powering it on.

Note: Updating the firmware is only possible when the transducer and a PC computer are connected directly (no other Master devices can be connected using the RS-485 interface).



Note: Switching off the power supply during the firmware updating process may result in an unreparable damage to the transducer!



5.8. Archiving measured values

5.8.1. Transducer memory structure

Standard P30U transducers (regardless of the manufacturing variant code) are equipped with a 4MB internal memory for storing data recorded by the transducer. The default recorded parameter is the displayed value, that is the measured value or value converted using mathematical functions and individual input characteristic. It is also possible to additionally record the second displayed value or displayed values and all queried values if RS-485 interface works in Master or Monitor mode. The internal transducer memory enables storing 534,336 records. The memory is of circular buffer type. After the memory becomes full, the oldest data is overwritten. The internal archive can be read, copied and cleared.

Transducers in P30U-X1XXXXXX variants are equipped with an SD/SDHC memory card slot enabling writing archive data to files on the external SD/SDHC memory card.

Transducers in P30U-X2XXXXXX variants are equipped with an 8GB internal file system memory (the capacity of the file system memory can be increased on a special order or due to manufacturer's needs) where the data from the internal memory are automatically copied to files. Data can be downloaded via the Ethernet interface using the FTP protocol.

Note: Changing the Archive → Arch. Val parameter value in the menu will delete the archive in the internal memory!!!



5.8.2. Internal memory









The internal transducer memory is divided into 8,192 pages. Each memory page can store 66 archive data records. Records on the page always begin from the page beginning and occupy the entire space of the page. Each memory page contains 528 bytes. The memory is divided into two areas: the first 8,096 memory pages are for the primary archive memory, whilst the last 96 pages are intended for reserve archive used during the operation of copying of archive to the SD/SDHC card or the file system internal memory. (total memory is $8,096 \times 528B + 96 \times 528B = 4,275,312$ Bytes).

The beginning of the archive data is defined by the number of the page on which there is the first record of the archive and by the initial byte which defines from which page byte the first record begins. The end of the archive is defined similarly by the number of the page on which there is the last record of the page on which there is the last record of the page and the byte where recording of the next archive record will begin.

Erasing the content of the archive internal memory is done by assigning parameters of the archive end to the archive beginning. Due to this operation, in case of deleting the archive, there is possibility to restore the memory content.

Data in the archive internal memory are stored as records consisting of 8 bytes. The current state of internal memory use can be indicated on the LCD display after selecting the function of displaying the unit with the indication of the internal memory use status at the lower line of LCD display. Table 18 describes the meaning of the internal memory status indicator.

Table 18

| | | | | | | | | |
|---------------------------------|---|---|---|---|---|---|---|---|
| Symbol |  |  |  |  |  |  |  |  |
| Percent of internal memory used | 87.5...100% | 75...87,5% | 62.5...75% | 50...62.5% | 37.5...50% | 25...37.5% | 12.5...25% | 0 ...12.5% |

5.8.2.1. Record structure

All data contained in the internal data memory are stored as records consisting of 8 bytes. The record structure has been presented in the table below.

Table 19

| Internal memory record (8 Bytes) | | | | | |
|----------------------------------|---------|---------|---|---------|---------|
| Recording time (4 Bytes) | | | Data archived in float format (4 Bytes) | | |
| Year- 2010 | Month | Day | Hour | Minute | Second |
| 6 bytes | 4 bytes | 5 bytes | 5 bytes | 6 bytes | 6 bytes |

Example 3: Example of coding a record in the internal memory – e.g. record No. 13 on the page 559

The record no. 13 (rec=13) on the page 559 is read out from the registers 4553 – 4556 (unsigned short registers – 2 bytes, 1 record includes 4 unsigned short registers) after entering the value 559 into the register 4500. The initial register containing the beginning of the record is found on the relationship: $R_0 = 4501 + \text{rec} * 4 = 4553$.

Table 20

| Register | HEX value |
|----------|-----------|
| 4553 | 0x0170 |
| 4554 | 0xBB95 |
| 4555 | 0xE87C |
| 4556 | 0xB942 |

rec = 0x**0170BB95**E87CB942

Data = 0xE87CB942 → (float) → 92.743958;

Table 21

| Recording time = 0x 0170BB95 → b1011100001011101110010101 | | | | | |
|--|---------|-----------|-----------|-----------|-------------|
| Year + 2010 | Month | Day | Hour | Minute | Second |
| 6 bytes | 4 bytes | 5 bytes | 5 bytes | 6 bytes | 6 bytes |
| 0 0 0 0 0 0 | 0 1 0 1 | 1 1 0 0 0 | 0 1 0 1 1 | 1 0 1 1 1 | 0 1 0 1 0 1 |
| 0 + 2010 | 5 | 24 | 11 | 46 | 21 |
| 10-05-24 11:46 | | | | | |



Rec : 2010-05-24 11:46:21 92.743958



5.8.2.2. Downloading archived data from the internal memory

Downloading of archive data from the internal memory is performed via the memory card (option) or via the RS-485 interface. Downloading data consists in reading subsequent memory pages containing data records. eCon software enables acquiring individual pages from the internal memory.

If the transducer has been manufactured in a variant supporting external SD/SDHC cards, then the archive data can automatically be copied to the memory card (this is the fastest method of obtaining

archive data). To do this, insert the SD/SDHC card in the transducer slot (contacts facing down) and make sure that the card has been properly mounted (the top right corner of the display shows a card icon ). The percent value of archive use, at which the data will automatically be copied to the card or to the file internal file system memory, must be set. This value is placed in register 7614 or can be changed using menu: Archi ve → Param. SD. For example if “20.0” is entered in register 7614, data will be collected in the internal transducer memory until the use of the internal memory reaches 20%, then the automatic archive copying to the SD/SDHC card or the file system internal memory process will begin. If the percent value of use will be higher, e.g. 99%, then data will be written on the SD/SDHC card less frequently, but the writing process will take longer. Writing data to the card is indicated with a progress bar graph displayed at the lower line of the LCD display. Do not remove the SD/SDHC card from the transducer slot if writing to the card is in progress, because this could lead to data corruption or device reset. Writing can be stopped and the card can be removed once it is unmounted (section 5.3.2).

It is also possible, to force archive copy to the SD/SDHC card or file system internal memory at any time by pressing the combination of   keys. If the transducer is in the variant with the Ethernet interface, the archive data can be downloaded from the file system memory via the FTP protocol using any FTP client software.

Note: If the transducer is connected to the FTP client, then copying the archive data from the internal memory to file system memory is blocked! In order to acquire current data from the archive, disconnect the FTP session and force archive copy (e.g. press   keys). After copying is finished connect again transducer with FTP client software.

5.8.3. Archiving configuration

Registers 4064-4069 (table 37) and transducer menu in Settings → Archi ve group (table 7) are used for configuring archiving parameters. The archiving can be constant or conditional.

Triggering conditional archiving can be implemented using one of four options presented in figure 25 (n-on, n-off, off, on). Continuous archiving is switched on by selecting the archiving type h-on, and it is switched off by selecting the option h-off.

a) n-on

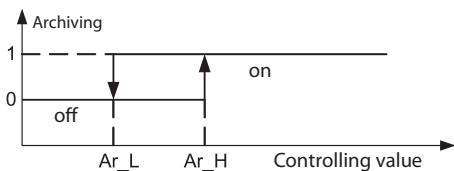

b) n-off

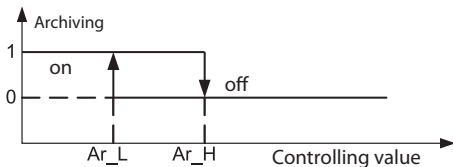

c) off

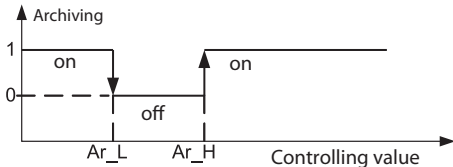

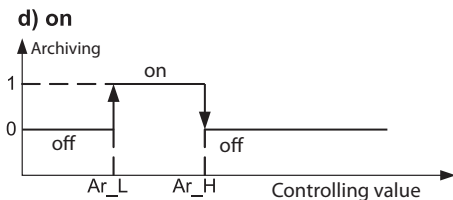

Fig.25. Conditional archiving types

Ar_L - Lower archiving threshold → OverLoAr → Register 7608

Ar_H – Upper archiving threshold → OverHi Ar → Register 7609

Example 4: Example 4: The transducer is configured for measurement of temperature - input Pt100 - 200. . 850°C. Conditional archiving of both displayed values triggered by the displayed value level:

Table 22

| Marking on the fig. | Register no. | Parameter symbol in the menu | Register value | Parameter value symbol in the menu |
|---------------------|--------------|------------------------------|----------------|------------------------------------|
| | 4064 | Arch. Val | 0 | Di spl Val |
| | 4065 | Param. Ar | 0 | Di spl Val |
| | 4066 | Ar. Mode | 2 | on |
| Ar_L | 7608 | OverLoAr | 50 | 35. 0 |
| Ar_H | 7609 | OverHi Ar | 60 | 45. 0 |
| | 4067 | Time Ar | 10 | 10 |
| | 4068 | Ar. Erase | 0 | No |
| | 4069 | Rec. ToSD | 0 | No |
| | 7614 | Param. SD | 99.9 | 99, 9 |

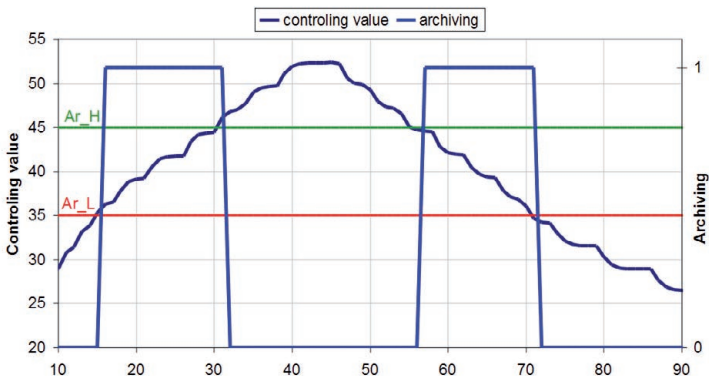

Fig.26. Example operation of on type conditional archiving configured according to the example from table 22 (Archiving “1” means that archiving is switched on).

5.8.4. Memory card or internal file system memory (option)

P30U transducers in P30U-X1XXXXXX manufacturing variants support memory cards are compliant with SD and SDHC standard. P30U transducers in P30U-X2XXXXXX manufacturing variants are equipped with a internal file system memory – 8GB memory capacity. FAT and FAT32 file systems are supported. If the memory card is not formatted, it should be formatted in the card reader using a PC. P30U transducer creates folders and files during operation, containing archive data. Before inserting the card into the transducer, check if the card write protection option is not switched on. Do not remove the memory card from the transducer before it is un-



mount (see section 5.3.2.) – unmount the card by pressing the following keys:   If a mounted card is removed, the corruption of the data stored on the memory card can be damaged. The memory card status is described in the transducer registers (sections 5.9.6, table 46). Directly after the card is inserted, the card status will be displayed for about 3 seconds on the display, as presented in the below table:

Table 23

| Message | Description |
|------------------|---|
| Eject SD | Card inserted, but not mounted (unmounted). |
| SD fail. | Card inserted but the mounting attempt has been unsuccessful. |
| UnlockSD | Card inserted and mounted successfully, but write-protected. After write protection is detected, the card is automatically unmounted. |
| SD OK or SDHC OK | Card inserted and mounted successfully. |
| Full SD | Card inserted and mounted successfully, but it is completely full. |
| Install. | Card inserted – mounting in progress |

An example number of records on an SD/SDHC card for 1 s archiving period for a single archiving value is the following:

- 64MB card: approx. 1 900 000 records (about 22 days)
- 2 GB card: approx. 60 800 000 records (about. 700 days)

Note: It is recommended to use industrial grade minimum class 6 SD/SDHC cards . Consumer grade cards with class 6 write speed can also be used (please note that consumer cards have operating temperature range limited to 0...40°C).



During the operation, the P30U transducer creates folders and files on the SD/SDHC memory card or in the internal file system memory. An example folder structure is shown on fig. 27.



Fig.27. Folder structure on the memory card (internal file system)

Apart from the ARCH folder where recorded data are stored, also the SYSTEM folder is created on the memory in which the *start.txt* file is stored to save the date and hour of installation of the memory card (also when starting the device after the power supply has been lost).

Data on the memory card or internal file system memory are stored as files located in folders corresponding to the device name and serial number – see fig. 27. File names correspond to the date of recording and have the following format *XXXX_YY.Dzz*, where *XXXX* → year, *YY* → month. Extension of files have following format: *Dzz*, where „zz” is subsequent number of file from the same month. For example, first archive file in May 2014 will have name: 2014_05.D00, subsequent file: 2014_05.D01 etc. There can be created maximum 32 files for each month (*.D00 ... *.D31). File number is changed automatically after reaching 12 MB file size if one or two values are recorded Di sp. Val or +2nd Val.

If transducer is configured for recording displayed value, second displayed value and all queried values, the maximum file size is calculated by transducer itself and depends on the number of queried values.

5.8.5. Archive file structure

Files containing archive data on an external SD/SDHC card or in the file system internal memory have a column structure, where the subsequent data columns are separated from another by a tab character. The first row contains the column header. Data records are placed in order in rows, and the fields of a given record are separated from one another with a tab character. The view of an example file has been shown in fig. 28.

| date | time | Disp.Value | 2-nd Disp.Val | R8000 | R8001 | R8002 | R8003 |
|------------|----------|--------------|---------------|-------|-------|-------|-------|
| 2014-04-28 | 13:51:32 | 2,082998e+01 | 1,164307e-03 | 1e+20 | 1e+20 | 1e+20 | 1e+20 |
| 2014-04-28 | 13:51:33 | 2,082541e+01 | 2,328614e-03 | 1e+20 | 1e+20 | 1e+20 | 1e+20 |
| 2014-04-28 | 13:51:34 | 2,082083e+01 | 3,492921e-03 | 1e+20 | 1e+20 | 1e+20 | 1e+20 |
| 2014-04-28 | 13:51:35 | 2,082083e+01 | 4,657228e-03 | 1e+20 | 1e+20 | 1e+20 | 1e+20 |
| 2014-04-28 | 13:51:36 | 2,082998e+01 | 5,821535e-03 | 1e+20 | 1e+20 | 1e+20 | 1e+20 |
| 2014-04-28 | 13:51:37 | 2,084304e+01 | 6,985843e-03 | 1e+20 | 1e+20 | 1e+20 | 1e+20 |
| 2014-04-28 | 13:51:38 | 2,084304e+01 | 8,15015e-03 | 1e+20 | 1e+20 | 1e+20 | 1e+20 |
| 2014-04-28 | 13:51:39 | 2,084304e+01 | 9,314456e-03 | 1e+20 | 1e+20 | 1e+20 | 1e+20 |
| 2014-04-28 | 13:51:40 | 2,084762e+01 | 1,047876e-02 | 1e+20 | 1e+20 | 1e+20 | 1e+20 |
| 2014-04-28 | 13:51:41 | 2,084762e+01 | 1,164307e-02 | 1e+20 | 1e+20 | 1e+20 | 1e+20 |
| 2014-04-28 | 13:51:42 | 2,084762e+01 | 1,280738e-02 | 1e+20 | 1e+20 | 1e+20 | 1e+20 |

Fig.28. Example data file

Subsequent fields contained in the row describing the record have the following meaning:

- date – date of data recording, “-” character is the date separator
- time – hour, minute, second of data registration, “:” character is the time separator
- Disp.Value – recorded displayed value of the transducer, the decimal separator depends on the language version set in the transducer menu – “,” character is the separator in the Polish version; “.” character is the separator for all other language versions; values are provided in the engineering format
- 2-nd Disp.Val – recorded second displayed value of the transducer, the decimal separator depends on the language version set in the transducer menu – “,” character is the separator in the Polish version; “.” character is the separator for all other language versions; values are provided in the engineering format
- R8000...R8049 – recorded registers from range 8000-8049 - values queried by transducer with RS-485 interface configured as Master or Monitor.

5.9. RS-485 Interface

The digital programmable P30U transducers are equipped with a serial interface in the RS-485 standard to communicate in computer systems and with other Master devices. Asynchronous character communication protocol MODBUS has been implemented on the serial interface. The transmission protocol describes the methods of information exchange between devices via a serial interface.

5.9.1. Serial interface connection

RS-485 standard allows direct connection of up to 32 devices on a single serial link with the length of up to 1200 m (with the baud rate 9600 b/s). In order to connect larger number of devices, it is necessary to use additional intermediate-and-separating systems such as PD51 made by LUMEL S.A. Connection diagram is presented on the Fig. 3. In order to obtain correct transmission, it is necessary to connect the lines A and B in parallel to their equivalents in other devices. Connection should be made with a shielded cable. The cable shield should be connected to the protective terminal as close to the transducer as possible (the shield should be connected to the protective terminal at one point only).

GND line is used for additional protection of the interface line in case of long connections. In such a case, GND signals of all devices on RS-485 bus should be connected.

To obtain a connection with a PC, an RS-485 interface card or an appropriate converter, e.g. PD51 or PD10, is required. The method of connecting devices has been shown on fig. 29.

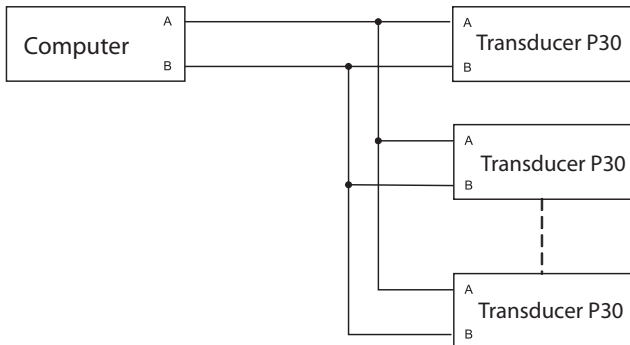

Fig.29. Method of connecting the RS-485 interface

The PC card transmission line marking depends on the card manufacturer.

5.9.2. MODBUS protocol description

The implemented protocol complies with Modicon's PI-MBUS-300 Rev G specification. P30U MODBUS protocol serial interface parameters :

- Transducer address 1..247.
- Transmission rate: 4800, 9600, 19200, 38400, 57600, 115200, 230400, 256000 [b/s].
- Operation mode: RTU with the frame format: 8n2, 8e1, 8o1, 8n1.
- Maximum time to start response: 200 ms (the response time may get longer up to 500ms during saving the data to the SD/SDHC card).

Serial interface configuration consists of setting the transmission rate, device address and the information unit format – protocol.

Note: Each transducer connected to the communication network must have:

- unique address, different from addresses of other devices connected to the network,
- identical baud rate and type of information unit.

5.9.3. Description of the implemented functions

The following MODBUS protocol functions have been implemented in P30U transducers:

- 03 (03h) – Read Holding Registers
- 04 (04h) – Read Input Registers
- 06 (06h) – Write Single Register
- 16 (10h) – Write Multiple registers
- 17 (11h) – Report Slave ID
- 43 (2Bh) - Encapsulated Interface Transport

Read Holding Registers (code 03h)

Example 5. Reading two float(32 bits) registers, first register address is 1DB0h (7600), register values (7600, 7601): 10.0, 100.0.

Request:

Table 24

| Device address | Function | Register address | | Number of registers | | CRC |
|----------------|----------|------------------|-----|---------------------|-----|-------|
| | | B1 | B0 | B1 | B0 | |
| 01h | 03h | 1Dh | B0h | 00h | 02h | C380h |

Response:

Table 25

| Device address | Function | Number of bytes | Register value 1DB0 (7600) | | | | Register value 1DB1 (7601) | | | | CRC |
|----------------|----------|-----------------|----------------------------|-----|-----|-----|----------------------------|-----|-----|-----|-------|
| | | | B3 | B2 | B1 | B0 | B3 | B2 | B1 | B0 | |
| 01h | 03h | 08h | 41h | 20h | 00h | 00h | 42h | C8h | 00h | 00h | E46Fh |

Example 6: Example 8. Reading two float 32-bit registers (7501,7502) located in 2x2 following 16-bit registers (7002, 7003, 7004, 7005), first register address is 1B5Ah (7002) – 32-bit register values: 25.68, 20.25.

Request:

Table 26

| Device address | Function | Register address | | Number of registers | | CRC |
|----------------|----------|------------------|-----|---------------------|-----|-------|
| | | B1 | B0 | B1 | B0 | |
| 01h | 03h | 1Bh | 5Ah | 00h | 04h | 62FEh |

Response:

Table 27

| Device address | Function | Number of bytes | Register value 1B5A h (7002) | | Register value 1B5Bh (7003) | | Register value 1B5Ch (7004) | | Register value 1B5Dh (7005) | | CRC |
|----------------|----------|-----------------|------------------------------|-----|-----------------------------|-----|------------------------------|-----|-----------------------------|-----|-------|
| | | | Register 7501 (32 bit) value | | | | Register 7502 (32 bit) value | | | | |
| | | | B3 | B2 | B1 | B0 | B3 | B2 | B1 | B0 | |
| 01h | 03h | 08h | 41h | CDh | 70h | A4h | 41h | A2h | 00h | 00h | 83D0h |

Example 7. Reading two float 32-bit registers (7501,7502) located in 2x2 following 16-bit registers (6002, 6003, 6004, 6005), first register address is 1772h (6002) - 32-bit register values: 25.68, 20.25.

Request:

Table 28

| Device address | Function | Register address | | Number of registers | | CRC |
|----------------|----------|------------------|-----|---------------------|-----|-------|
| | | B1 | B0 | B1 | B0 | |
| 01h | 03h | 17h | 72h | 00h | 04h | E1A6h |

Response:

Table 29

| Device address | Function | Number of bytes | Register value | | Register value | | Register value | | Register value | | CRC |
|----------------|----------|-----------------|------------------------------|-----|----------------|-----|------------------------------|-----|----------------|-----|-------|
| | | | 1772h (6002) | | 1773h (6003) | | 1774h (6004) | | 1775h (6005) | | |
| | | | Register 7501 (32 bit) value | | | | Register 7502 (32 bit) value | | | | |
| | | B3 | B2 | B1 | B0 | B3 | B2 | B1 | B0 | | |
| 01h | 03h | 08h | 70h | A4h | 41h | CDh | 00h | 00h | 41h | A2h | E411h |

Write Single Register (code 06h)

Example 8. Example 10. Writing value "543" to the register 0FA1h (4001)

Table 30

| Device address | Function | Register address | | Number of registers | | CRC |
|----------------|----------|------------------|-----|---------------------|-----|-------|
| | | B1 | B0 | B1 | B0 | |
| 01h | 06h | 0Fh | A1h | 02h | 1Fh | 9B94h |

Response:

Table 31

| Device address | Function | Register address | | Number of registers | | CRC |
|----------------|----------|------------------|-----|---------------------|-----|-------|
| | | Hi | Lo | Hi | Lo | |
| 01h | 06h | 0Fh | A1h | 02h | 1Fh | 9B94h |

Write Multiple registers (code 10h)

Example 9. Writing value “20” and “200” to registers 1DB0h (7600) and 1DB1h (7601)

Request:

Table 32

| Device address | Function | Register address.Hi | Register address.Lo | Number of registers Hi | Number of registers Lo | Number of bytes | Register value 1DB0 (7600) | | | | Register value 1DB1 (7601) | | | | CRC |
|----------------|----------|---------------------|---------------------|------------------------|------------------------|-----------------|----------------------------|-----|-----|-----|----------------------------|-----|-----|-----|-------|
| | | | | | | | B1 | B0 | B3 | B2 | B1 | B0 | B3 | B2 | |
| 01h | 10h | 1Dh | B0h | 00h | 02h | 08h | 41h | A0h | 00h | 00h | 43h | 48h | 00h | 00h | C9E2h |

Response:

Table 33

| Device address | Function | Register address | | Number of registers | | CRC |
|----------------|----------|------------------|-----|---------------------|-----|-------|
| | | B1 | B0 | B1 | B0 | |
| 01h | 10h | 1Dh | B0h | 00h | 02h | 4643h |

Report Slave ID (code 11h)

Example 10. Report slave ID

Request:

Table 34

| Device address | Function | CRC |
|----------------|----------|-------|
| 01h | 11h | C02Ch |

Response:

Table 35

| Device address | Function | Number of bytes | Device ID | Device state | Device-dependent field | | CRC |
|----------------|----------|-----------------|-----------|--------------|------------------------|---|-------|
| | | | | | Firm-ware v 2.00 | Registers 4304, 4305 describing the serial number and hardware configuration of the transducer (serial no 13100001) | |
| 01h | 11h | 08h | C1h | FFh | 02h 00h | A0h 01h 6Ch 0Dh | 69FCh |

Device-dependent field – 4 bytes corresponding to register value 4304, 4305 see table 41 manufacturing status 1, manufacturing status 2.

5.9.4. Register map

In the P30U transducer the data is stored in 16- and 32-bit registers. The process variables and parameters of the device are stored in the different address space depending on the variable type. The bits in the 16-bit registers are numbered from the least significant to the most significant (b0 ... b15). The 32-bit registers (4 Bytes) contain floating-point values in IEEE-754 standard. Bytes sequence: B3 B2 B1 B0 – the most significant byte is sent as the first one. 16-bit registers which represents 32-bit values on a two following registers are multiplied at different address field with different bytes (word) order: B1 B0 B3 B2 (table. 36).

Register map of the P30U transducer is shown in table 36.

Note: All the given addresses are physical addresses. In some computer programs logical addressing is applied, then the addresses should be increased by 1.

Table 36

| Address range | Value type | Description |
|---------------|----------------------|---|
| 4000 - 4127 | integer (16 bits) | The value is located in the 16-bit register |
| 4300 - 4325 | integer (16 bits) | The value is located in the 16-bit register |
| 4400 - 4439 | integer (16 bits) | The value is located in the 16-bit register |
| 4500 - 4764 | integer (16 bits) | The value is located in the 16-bit register |
| 6000-6075 | float (32 bits) | The value is located in two following 16-bit registers. Registers contain the same data as 32-bit registers from the area 7500-7537. Registers are readout type only. Byte order (B1, B0, B3, B2) |
| 7000 -7075 | float (32 bits) | The value is located in two following 16-bit registers. Registers contain the same data as 32-bit registers from the area 7500-7537. Registers are readout type only. Byte order (B3, B2, B1, B0) |
| 6200-6337 | float (32 bits) | The value is located in two following 16-bit registers. Registers contain the same data as 32-bit registers from the area 7600-7719. Registers can be read and written. Byte order (B1, B0, B3, B2) |
| 7200-7337 | float (32 bits) | The value is located in two following 16-bit registers. Registers contain the same data as 32-bit registers from the area 7600-7719. Registers can be read and written. Byte order (B3, B2, B1, B0) |
| 7500-7537 | float (32 bits) | The value is located in the 32-bit register. Registers contain measured and calculated data by the transducer. Registers are readout type only. Byte order (B3, B2, B1, B0) |

| | | |
|-----------|--------------------|---|
| 7600-7668 | float (32 bits) | The value is located in the 32-bit register. Registers can be read and written. Byte order (B3,B2,B1,B0) |
| 8000-8049 | float (32 bits) | The value is located in the 32-bit register. Registers can be read and written. Byte order (B3,B2,B1,B0) |
| 8100-8199 | float (32 bits) | The value is located in two following 16-bit registers. Registers contain the same data as 32-bit registers from the area 8000-8099. Registers can be read and written. Byte order (B3, B2, B1, B0) |
| 8200-8299 | float (32 bits) | The value is located in two following 16-bit registers. Registers contain the same data as 32-bit registers from the area 8000-8099. Registers can be read and written. Byte order (B1, B0, B3, B2) |

5.9.5. Read and Write registers

Table 37



| Register address (16 bit registers) | Name | Write(w)/ read (r) | Range | Default value | Description | |
|--|-----------------------|--------------------|--------|---------------|-------------|----------------------|
| 4000 | Input | w/ r | 0...34 | 22 | Input type | |
| | | | | | Value | |
| | | | | | 0 | reserved |
| | | | | | 1 | Voltage -10...10V |
| | | | | | 2 | Voltage -24...24V |
| | | | | | 3 | Current -20...20mA |
| | | | | | 4 | Resistance 0...400Ω |
| | | | | | 5 | Resistance 0...2000Ω |
| | | | | | 6 | Resistance 0...5500Ω |
| | | | | | 7 | Pt100 -200...850 °C |
| | | | | | 8 | Pt250 -200...600 °C |
| | | | | | 9 | Pt250 -200...850 °C |
| | | | | | 10 | Pt500 -200...180 °C |
| | | | | | 11 | Pt500 -200...850 °C |
| | | | | | 12 | Pt1000 -200...250 °C |
| | | | | | 13 | Pt1000 -200...850 °C |
| | | | | | 14 | Ni100 -60...180 °C |
| 15 | Ni1000 -60...150 °C | | | | | |
| 16 | Ni100-LG -60...180 °C | | | | | |



| | | | | | | |
|------|----------|-----|------------|------|--|---|
| | | | | | 17 | Ni1000-LG -60...180 °C |
| | | | | | 18 | Cu100 -50...180 °C |
| | | | | | 19 | Voltage -5...20mV |
| | | | | | 20 | Voltage -75...75mV |
| | | | | | 21 | Voltage -200...200mV |
| | | | | | 22 | Thermocouple J 0...400°C |
| | | | | | 23 | Thermocouple J -200...1200°C |
| | | | | | 24 | Thermocouple K 0...400°C |
| | | | | | 25 | Thermocouple K -200...1370°C |
| | | | | | 26 | Thermocouple S 0...1760°C |
| | | | | | 27 | Thermocouple N -20...420°C |
| | | | | | 28 | Thermocouple N -200...1300°C |
| | | | | | 29 | Thermocouple E -40...260°C |
| | | | | | 30 | Thermocouple E -200...1000°C |
| | | | | | 31 | Thermocouple R 0...1760°C |
| | | | | | 32 | Thermocouple T -200...400°C |
| | | | | | 33 | Thermocouple B 400...1800°C |
| | | | | | 34 | RS-485 mode |
| 4001 | AvgTime | w/r | 75...20000 | 1000 | Averaging time of the measured value [ms] | |
| 4002 | Point No | w/r | 1...21 | 1 | Number of individual characteristics pointst. For the value of 1 individual characteristic is switched off. Sections of individual characteristic are defined with Xn and Yn parameters, where n – point number. | |
| 4003 | Compens. | w/r | 0...1 | 1 | Compensation type of: | |
| | | | | | - cold junction temperature for thermocouples | |
| | | | | | - cords resistance for measuring resistance and temperature from thermistor sensors | |
| | | | | | Value | Description |
| | | | | | 1 | Automatic compensation |
| | | | | | 0 | Manual compensation (compensation value should be written into 7668 register) |

| | | | | | | |
|--------------------|-----------|---------|--------|---|--|---|
| 4004 | EraseExt | w/ r | 0...3 | 0 | Clears minimum and maximum values with time and date of occurrence on the main input | |
| | | | | | Value | Description |
| | | | | | 0 | without changes |
| | | | | | 1 | erasing minimum value |
| | | | | | 3 | erasing minimum and maximum value |
| 4005 | No. OfErr | w/ r | 0...10 | 2 | Number of acceptable errors in modbus RS-485 answers when transducers interface works in Master mode | |
| 4006 | Math Fun | w/ r | 0...5 | 0 | Value | Description |
| | | | | | 0 | Mathematical functions on main input switched off |
| | | | | | 1 | Square of measured value |
| | | | | | 2 | Square of measured value |
| | | | | | 3 | Inverse of measured value |
| | | | | | 4 | Inverse square of measured value |
| | | | | | 5 | Inverse square root of measured value |
| 4007 | Medi an | w/ r | 1...50 | 3 | Number of median filter samples | |
| 4008... ...4016 | | w/ r | | | RESERVED | |
| 4017 | | w/ r | 0...1 | 0 | Erase transducer status registers | |
| | | | | | Value | Description |
| | | | | | 0 | without changes |
| | | | | | 1 | erasing status register |
| 4018 | Dec. P 2 | w/ r | 0...4 | 0 | Minimum decimal point of the second displayed value (Value displayed on the lower line of LCD) | |
| | | | | | Value | Description |
| | | | | | 0 | 0.0000 |
| | | | | | 1 | 00.000 |
| | | | | | 2 | 000.00 |
| | | | | | 3 | 0000.0 |
| | | | | | 4 | 00000 |

| | | | | | | | | | | |
|------|-------------|---------|----------------|---|-------------------|---|-------|------|-------|----------------------|
| 4019 | Bckl . I nt | w/ r | 1...10 | 7 | Value Description | | | | | |
| | | | | | 1 | LCD display backlight 10% of maximum backlight | | | | |
| | | | | | ... | | | | | |
| | | | | | 10 | LCD display backlight 100% of maximum backlight | | | | |
| 4020 | Uni t. | w/ r | 0...57 | 1 | Displayed unit | | | | | |
| | | | | | Value | Unit | Value | Unit | Value | Unit |
| | | | | | 0 | | 20 | kVAh | 40 | sz t |
| | | | | | 1 | V | 21 | MVAh | 41 | i mp |
| | | | | | 2 | A | 22 | Hz | 42 | r ps |
| | | | | | 3 | mV | 23 | KHz | 43 | m/s |
| | | | | | 4 | kV | 24 | Ω | 44 | l /s |
| | | | | | 5 | mA | 25 | kΩ | 45 | obr/mi |
| | | | | | 6 | kA | 26 | °C | 46 | r pm |
| | | | | | 7 | W | 27 | °F | 47 | mm/mi n |
| | | | | | 8 | kW | 28 | K | 48 | m/mi n |
| | | | | | 9 | MW | 29 | % | 49 | l /mi n |
| | | | | | 10 | var | 30 | %RH | 50 | m ³ /mi n |
| | | | | | 11 | kvar | 31 | pH | 51 | sz t/h |
| | | | | | 12 | Mvar | 32 | kg | 52 | m/h |
| | | | | | 13 | VA | 33 | bar | 53 | km/h |
| | | | | | 14 | kVA | 34 | m | 54 | m ³ /h |
| | | | | | 15 | MVA | 35 | l | 55 | kg/h |
| | | | | | 16 | kWh | 36 | s | 56 | l /h |
| | | | | | 17 | MWh | 37 | h | 57 | User defined |
| 18 | kVarh | 38 | m ³ | | | | | | | |
| 19 | MVarh | 39 | obr | | | | | | | |

| | | | | | | |
|------|------------|---------|-----------|------|---|--|
| 4021 | Deci mal P | w/ r | 0...4 | 0 | Minimum decimal point of the displayed value – display format. | |
| | | | | | Value | Description |
| | | | | | 0 | 0.0000 |
| | | | | | 1 | 00.000 |
| | | | | | 2 | 000.00 |
| | | | | | 3 | 0000.0 |
| | | | | | 4 | 00000 |
| 4022 | Bckl i ght | w/ r | 0...61 | 61 | LCD display backlight time | |
| | | | | | Value | Description |
| | | | | | 0 | always off |
| | | | | | 1..60 | active for 1...60 seconds |
| | | | | | 61 | always on |
| 4023 | Uni t 2 | w/ r | 0...57 | 0 | Second displayed value unit, values similar to register 4020 | |
| 4024 | Di sp. Reg | w/ r | 0...65535 | 7515 | Number of register displayed at the lower line of the display display (to display float register value located in 16 bit registers, enter the corresponding 32 bit register number) | |
| 4025 | | w/ r | 0...1 | 0 | Clearing alarm indicating on LED 's (A1, A2) | |
| 4026 | Param. A1 | w/ r | 0...3 | 0 | Alarm 1 control input value | |
| | | | | | Value | Description |
| | | | | | 0 | displayed value – value calculated from the main input |
| | | | | | 1 | value calculated from the auxiliary input |
| | | | | | 2 | Real Time Clock |

| | | | | | | |
|------|--|---------|---------|---|---|--|
| 4027 | Typ A1 | | | 0 | Alarm 1 type (description – section 5.5.3.) | |
| | | | | | Value | Description |
| | | | | | 0 | n-on |
| | | | | | 1 | n-off |
| | | | | | 2 | on |
| | | | | | 3 | off |
| | | | | | 4 | h-on |
| | | | | | 5 | h-off |
| 4028 | DI yOnA1 | w/ r | 0...900 | 0 | Alarm 1 activation delay (s) | |
| 4029 | DI yOffA1 | w/ r | 0...900 | 0 | Alarm 1 deactivation delay (s) | |
| 4030 | OnLockA1 | w/ r | 0...900 | 0 | Alarm 1 reactivation delay (s) | |
| 4031 | SgKeepA1 | w/ r | 0...1 | 1 | Alarm 1 indication mode | |
| | | | | | Value | Description |
| | | | | | 0 | alarm occurrence is indicated using A1 LED, alarm deactivation switches off A1 LED |
| 1 | alarm occurrence is indicated using A1 LED, alarm deactivation causes blinking of A1 LED until the alarm is reconfigured or cleared with key   | | | | | |
| 4032 | | w/ r | | | RESERVED | |
| 4033 | Param. A2 | w/ r | 0...3 | 0 | Alarm 2 control input value | |
| | | | | | Value | Description |
| | | | | | 0 | displayed value – value measured and calculated from the input |
| | | | | | 1 | Real Time Clock |
| 2 | the second displayed value – Value set as Di sp. Reg parameter | | | | | |

| | | | | | | |
|------|--|---------|---------|---|---|--|
| 4034 | Typ A2 | | | 0 | Alarm 2 type (Description – section 5.5.3.) | |
| | | | | | Value | Description |
| | | | | | 0 | n-on |
| | | | | | 1 | n-off |
| | | | | | 2 | on |
| | | | | | 3 | off |
| | | | | | 4 | h-on |
| | | | | | 5 | h-off |
| 4035 | DI yOnA2 | w/ r | 0...900 | 0 | Alarm 2 activation delay (s) | |
| 4036 | OpoWyl A2 | w/ r | 0...900 | 0 | Alarm 2 deactivation delay (s) | |
| 4037 | OpoPonA2 | w/ r | 0...900 | 0 | Alarm 2 reactivation delay (s) | |
| 4038 | PodSygA2 | w/ r | 0...1 | 1 | Alarm 2 indication mode | |
| | | | | | Value | Description |
| | | | | | 0 | alarm occurrence is indicated using A2 LED, alarm deactivation switches off A2 LED |
| 1 | alarm occurrence is indicated using A2 LED, alarm deactivation causes blinking of A2 LED until the alarm is reconfigured or cleared with key   | | | | | |
| 4039 | | w/ r | | | RESERVED | |
| 4040 | Param. An | w/ r | 0...1 | 0 | Value which controls analog output | |
| | | | | | Value | Description |
| | | | | | 0 | displayed value – value measured calculated from the input |
| | | | | | 1 | Real Time Clock |
| | | | | | 2 | the second displayed value – Value set as Di sp. Reg parameter |

| | | | | | | |
|------|----------|---------|---------|---|---|---|
| 4041 | OverServ | w/ r | 0...1 | 0 | Analog output overflow management | |
| | | | | | Value | Description |
| | | | | | 0 | Switched off |
| | | | | | 1 | Switched on |
| 4042 | Mode | w/ r | 0...2 | 0 | RS-485 interface working mode | |
| | | | | | 0 | RS-485 interface works in modbus Slave mode, transducer waits for requests and responds on request addressed to its address |
| | | | | | 1 | Transducer monitors traffic on RS-485 interface and acts on data other devices transmit |
| | | | | | 2 | RS-485 interface works in modbus Master mode, transducer sends requests and waits for reply from Slave device |
| 4043 | Address | w/ r | 0...247 | 1 | RS-485 MODBUS network address. Enter 0 to switch off the interface. | |
| 4044 | ModeUnit | w/ r | 0...3 | 0 | RS-485 interface transmission mode | |
| | | | | | 0 | RTU 8N2 |
| | | | | | 1 | RTU 8E1 |
| | | | | | 2 | RTU 8O1 |
| | | | | | 3 | RTU 8N1 |
| 4045 | BaudRate | w/ r | 0...7 | 1 | RS-485 interface transmission baudrate | |
| | | | | | Value | Description |
| | | | | | 0 | 4800 bit/s |
| | | | | | 1 | 9600 bit/s |
| | | | | | 2 | 19200 bit/s |
| | | | | | 3 | 38400 bit/s |
| | | | | | 4 | 57600 bit/s |
| | | | | | 5 | 115200 bit/s |
| | | | | | 6 | 230400 bit/s |
| | | | | | 7 | 256000 bit/s |

| | | | | | | |
|-----------|---|-----|-----------|------|---|---|
| 4046 | Mast. Fun | w/r | 0...1 | 0 | Selection of modbus Master function | |
| | | | | | 0 | function 0x03 |
| | | | | | 1 | function 0x04 |
| 4047 | | w/r | | | RESERVED | |
| 4048 | AnswTime | w/r | 10...5000 | 1000 | The maximal response time of the device working in Master or Monitor RS-485 interface mode [ms] | |
| 4049 | Val Type | w/r | 0...12 | 6 | Type of polled / monitored values in either Master or Monitor RS-485 interface mode | |
| | | | | | char 8 | char type value (8 bits with sign) |
| | | | | | uchar 8 | unsigned char type value (8 bits without sign) |
| | | | | | short 16 | short type value (16 bits with sign) |
| | | | | | ushort 16 | unsigned short type value (16 bits without sign) |
| | | | | | long 32 | long type value (32 bits with sign) |
| | | | | | ulong 32 | unsigned long type value (32 bits without sign) |
| | | | | | float 32 | float type value (32 bits, floating point value with sign) |
| | | | | | sfloat2x16 | swapped float type value, 32 bits floating point value placed on two 16-bit registers (Byte order 3,2,1,0) |
| | | | | | float2x16 | float type value, 32 bits floating point value placed on two 16-bit registers (Byte order 1,0,3,2) |
| | | | | | long2x16 | long type value (32 bits with sign) placed on two 16-bit registers, (Byte order 1,0,3,2) |
| | | | | | slong2x16 | swapped long type value (32 bits with sign) placed on two 16-bit registers, (Byte order 3,2,1,0) |
| ulong2x16 | unsigned long type value (32 bits without sign) placed on two 16-bit registers, (Byte order 1,0,3,2) | | | | | |
| ulong2x16 | unsigned swapped long type value (32 bits without sign) placed on two 16-bit registers, (Byte order 3,2,1,0) | | | | | |

| | | | | | | |
|------|-----------|-----|------------|------|---|--|
| 4050 | Base. Reg | w/r | 0...65535 | 7510 | Number of polled / monitored base register in Master / Monitor mode of RS-485 interface | |
| 4051 | No. ofVal | w/r | 0...50 | 1 | Number of polled values in Master / Monitor mode of RS-485 interface | |
| 4052 | Interw. | w/r | 1...36000 | 10 | Polling interval in Master RS-485 mode | |
| 4053 | | w/r | 0...1 | 0 | Update transmission parameters. Accepts entered RS-485 interface settings. | |
| 4054 | Language | w/r | 0...3 | 0 | Transducer menu language: | |
| | | | | | Value | Description |
| | | | | | 0 | Polish |
| | | | | | 1 | English |
| | | | | | 2 | German |
| 3 | French | | | | | |
| 4055 | Fabr. Par | w/r | 0...1 | 0 | Restore default settings | |
| | | | | | Value | Description |
| | | | | | 0 | without changes |
| | | | | | 1 | restore default settings |
| 4056 | Securi ty | w/r | 0...9999 | 0 | Password for changing parameters from menu | |
| | | | | | Value | Description |
| | | | | | 0 | without changes |
| | | | | | ... | Entering parameter edition mode prompts for password |
| 4057 | Ti me | w/r | 0...2359 | - | Current time – hour, minute | |
| | | | | | This parameter uses hhmm format, where: hh – hours, mm – minutes. Wrong hour will set value to 23 and wrong minutes will set value to 59. Register 4055 is cleared after writing to register 4057 | |
| 4058 | | w/r | 0...60 | - | Current time - seconds | |
| 4059 | | r | 0...100 | - | Current time – seconds | |
| 4060 | Date | w/r | 101...1231 | - | Current date in format month *100 + day | |

| | | | | | | |
|------|-----------|-----|--------------------|---|---|---|
| 4061 | | w/r | 2001... ...2099 | - | Current year in YYYY format | |
| 4062 | | w/r | 0...1 | 0 | Auto change of summer/winter time and vice versa | |
| | | | | | Value | Description |
| | | | | | 0 | Switched off |
| | | | | | 1 | Switched on |
| 4063 | | w/r | | - | RESERVED | |
| 4064 | Arch. Val | w/r | 0...2 | 0 | Select archived values Note: changing register value clears the archive in the internal memory!!! | |
| | | | | | Value | Description |
| | | | | | 0 | displayed value only – value calculated from the main input |
| | | | | | 1 | displayed value and second displayed value |
| | | | | | 2 | displayed value, second displayed value and all required registers in Master or Monitor RS-485 mode |
| 4065 | Param. Ar | w/r | 0...2 | 0 | Type of input value which controls conditional archiving | |
| | | | | | Value | Description |
| | | | | | 0 | displayed value – value calculated from the main input |
| | | | | | 1 | time |
| | | | | | 2 | the second displayed value |
| 4066 | Ar. Mode | w/r | 0...5 | 5 | Archiving triggering condition (Description – section.5.8) | |
| | | | | | Value | Description |
| | | | | | 0 | n-on |
| | | | | | 1 | n-off |
| | | | | | 2 | on |
| | | | | | 3 | off |
| | | | | | 4 | h-on |
| | | | | | 5 | h-off |

| | | | | | | |
|-----------------|---|-----|-----------|-------|---|---|
| 4067 | Time Ar | w/r | 1...3600 | 10 | Archiving period (s) | |
| 4068 | Ar. Erase | w/r | 0...1 | 0 | Erasing internal archive | |
| 4069 | Rec. ToSD | w/r | 0...1 | 0 | Copy internal archive into SD/SDHC card (variant P30U-X1XXXXXX) or into internal file system memory (variant P30U-X2XXXXXX) | |
| | | | | | Value | Description |
| | | | | | 0 | without changes |
| | | | | | 1 | start copying the archive |
| 4070.. .4076 | | w/r | | - | RESERVED | |
| 4077 | | w/r | 0...2 | 0 | Value | Description |
| | | | | | 0 | without changes |
| | | | | | 1 | write the transducer configuration to P30U_PAR.CON file on the external SD/SDHC card or on the internal file system memory |
| 2 | read the transducer configuration from P30U_PAR.CON file stored on the external SD/SDHC card or on the internal file system memory | | | | | |
| 4078 .4079 | | w/r | | - | RESERVED | |
| 4080 | EthStdPa | w/r | 0...1 | 0 | Ethernet interface default settings | |
| | | | | | Value | Description |
| | | | | | 0 | without changes |
| 1 | Restore default Ethernet interface parameters | | | | | |
| 4081 | addrIP32 | w/r | 0...65535 | 49320 | Third and second byte (B3.B2) of transducer's IP address, value displayed in a decimal format, IPv4 address format: B3.B2.B1.B0 | |
| 4082 | addrIP10 | w/r | 0...65535 | 286 | First and zero byte (B1.B0) of transducer's IP address, value displayed in a decimal format, IPv4 address format: B3.B2.B1.B0 | |
| 4083 | mask 32 | w/r | 0...65535 | 65535 | Third and second byte (B3.B2) of transducer's subnet mask, value displayed in decimal format, mask format: B3.B2.B1.B0 | |

| | | | | | | |
|------|---|-----|------------|-------|--|---|
| 4084 | mask 10 | w/r | 0...65535 | 65280 | First and zero byte (B1.B0) of transducer's subnet mask, value displayed in a decimal format, mask format: B3.B2.B1.B0 | |
| 4085 | MAC 54 | o | 0...65535 | - | Fifth and fourth byte (B5.B4) of transducer's MAC address, value displayed in a decimal format; format B5:B4:B3:B2:B1:B0 | |
| 4086 | MAC 32 | o | 0...65535 | - | Third and second byte (B3.B2) of transducer's MAC address, value displayed in a decimal format; format B5:B4:B3:B2:B1:B0 | |
| 4087 | MAC 10 | o | 0...65535 | - | First and zero byte (B1.B0) of transducer's MAC address, value displayed in a decimal format; format B5:B4:B3:B2:B1:B0 | |
| 4088 | gate 32 | w/r | 0...65535 | 49320 | Third and second byte (B3.B2) of transducer's default gateway, value displayed in a decimal format, gateway address format: B3.B2.B1.B0 | |
| 4089 | gate 10 | w/r | 0...65535 | 257 | First and zero byte (B1.B0) of transducer's default gateway, value displayed in a decimal format, gateway address format: B3.B2.B1.B0 | |
| 4090 | DHCP | w/r | 0...1 | 1 | Switching DHCP client on/off (enables automatic transducer configuration which is connected to a network so it can communicate on that network using the Internet Protocol IP) | |
| | | | | | Value | Description |
| | | | | | 0 | DHCP switched off – manually configure transducer's IP address and subnet mask; |
| 1 | DHCP switched on, after powering on or selecting from menu option ReI nI tE t the transducer will receive IP address, subnet mask and gateway address from the DHCP server, the gateway address will be the address of the server that assigned parameters to the transducer; | | | | | |
| 4091 | LnkSpeed | w/r | 0...2 | 0 | Ethernet interface transmission rate | |
| | | | | | Value | Description |
| | | | | | 0 | automatic |
| | | | | | 1 | 10 Mb/s |
| 2 | 100 Mb/s | | | | | |
| 4092 | p. comFTP | w/r | 20...65535 | 21 | FTP server command port number | |
| 4093 | Port FTP | w/r | 20...65535 | 1025 | FTP server data port number | |

| | | | | | | |
|----------------|------------|---------|------------|-----|--|--|
| 4094 | no. c. TCP | w/ r | 1...4 | 4 | Maximum number of simultaneous connections with Modbus TCP/IP service | |
| 4095 | TimeMbus | w/ r | 10...600 | 60 | Modbus TCP/IP service port closing time, the value is given in seconds | |
| 4096 | AddrMTC | w/ r | 0...255 | 1 | Device address for Modbus TCP/IP protocol | |
| 4097 | PortMbus | w/ r | 0...65535 | 502 | Modbus TCP/IP port number | |
| 4098 | PortHTTP | w/ r | 80...65535 | 80 | HTTP server port number | |
| 4099 | ReInitEt | w/ r | 0...1 | 0 | Apply a new Ethernet interface parameters | |
| | | | | | Value | Description |
| | | | | | 0 | without changes |
| | | | | | 1 | save a new Ethernet interface parameters and reinitialize the Ethernet interface |
| 4100.. 4127 | | w/ r | | | RESERVED | |

Table 38

| Register address (16 bit registers, $1 \leq n \leq 5$) | Write(w) /read(r) | Range | Default value | Description |
|---|----------------------|--------|------------------|---|
| 4400+8*(n-1) | w/r | 0...31 | - | Filling custom unit character n of line 1 (section 5.5.4.1.) |
| 4401+8*(n-1) | w/r | 0...31 | - | Filling custom unit character n of line 2 (section 5.5.4.1.) |
| 4402+8*(n-1) | w/r | 0...31 | - | Filling custom unit character n of line 3 (section 5.5.4.1.) |
| 4403+8*(n-1) | w/r | 0...31 | - | Filling custom unit character n of line 4 (section 5.5.4.1.) |
| 4404+8*(n-1) | w/r | 0...31 | - | Filling custom unit character n of line 5 (section 5.5.4.1.) |
| 4405+8*(n-1) | w/r | 0...31 | - | Filling custom unit character n of line 6 (section 5.5.4.1.) |
| 4406+8*(n-1) | w/r | 0...31 | - | Filling custom unit character n of line 7 (section 5.5.4.1.) |
| 4407+8*(n-1) | w/r | 0...31 | - | Filling custom unit character n of line 8 (section 5.5.4.1.) |

Table 39

| Register address (16 bit regi- sters) | Write (w) /read (r) | Range | Default value | Description |
|--|------------------------------|-----------|------------------|--|
| 4500 | w/r | 0...8096 | 0 | Number of memory page that user want to download. Writing page number |
| 4501 | r | 0...65535 | - | Two first data bytes from the page indicated by register 4500 |
| 4502 | r | 0...65535 | - | Two consecutive bytes |
| --- | --- | --- | - | --- |
| 4764 | r | 0...65535 | - | Two last memory page bytes (byte 526 and 527) |

Table 40

| Value located in two following 16 bit registers. These registers contain identical data as 32 bit registers from 7600... range | Value located in 32 bit registers | Symbol | Write (w) /read (r) | Range | Default value | Description |
|--|-----------------------------------|-----------|---------------------|-----------------------|---------------|-------------------------------|
| 6200...6203 /7200...7203 | 7600 | | | | - | RESERVED |
| 6204/7204 | 7602 | Over Lo | w/ r | -99999... ...99999 | -99999 | Lower display range threshold |
| 6206/7206 | 7603 | Over Hi | w/ r | -99999... ...99999 | 99999 | Upper display range threshold |
| 6208/7208 | 7604 | OverLoA1 | w/ r | -99999... ...99999 | 0 | Lower alarm 1 threshold |
| 6210/7210 | 7605 | OverHi A1 | w/ r | -99999... ...99999 | 20 | Upper alarm 1 threshold |
| 6212/7212 | 7606 | OverLoA2 | w/ r | -99999... ...99999 | 0 | Lower alarm 2 threshold |
| 6214/7214 | 7607 | OverHi A2 | w/ r | -99999... ...99999 | 20 | Upper alarm 2 threshold |
| 6216/7216 | 7608 | OverLoAr | w/ r | -99999... ...99999 | 0 | Archive lower threshold |
| 6218/7218 | 7609 | OverHi Ar | w/ r | -99999... ...99999 | 20 | Archive upper threshold |

| | | | | | | |
|-----------------------------|-----------------|-----------|-----|-----------------------|-----|--|
| 6220/7220 | 7610 | Anl n Lo | w/r | -99999... ...99999 | 0 | Analog output individual characteristic – lower input threshold |
| 6222/7222 | 7611 | Anl n Hi | w/r | -99999... ...99999 | 100 | Analog output individual characteristic – upper input threshold |
| 6224/7224 | 7612 | AnOut Lo | w/r | -24...24 | 0 | Analog output individual characteristic – lower output threshold |
| 6226/7226 | 7613 | AnOut Hi | w/r | -24...24 | 20 | Analog output individual characteristic – upper output threshold |
| 6228/7228 | 7614 | Param. SD | w/r | 5 ... 95 | 50 | Percent of internal archive use which triggers automatic copying to SD/SDHC card |
| 6230...6243/ 7230...7243 | 7615... 7621 | | w/r | | | RESERVED |
| 6244/7244 | 7622 | X1 | w/r | -99999... ...99999 | 0 | Individual characteristic point (measured value) Point no. 1. |
| 6246/7246 | 7623 | Y1 | w/r | -99999... ...99999 | 0 | Expected value for point no.1. |
| 6248/7248 | 7624 | X2 | w/r | -99999... ...99999 | 100 | Individual characteristic point no. 2. |
| 6250/7250 | 7625 | Y2 | w/r | -99999... ...99999 | 100 | Expected value for point no.2. |
| 6252/7252 | 7626 | X3 | w/r | -99999... ...99999 | 200 | Individual characteristic point no. 3. |
| 6254/7254 | 7627 | Y3 | w/r | -99999... ...99999 | 200 | Expected value for point no.3. |

| | | | | | | |
|-----------|------|-----|---------|-----------------------|------|---|
| 6256/7256 | 7628 | X4 | w/ r | -99999... ...99999 | 300 | Individual characteristic point no. 4. |
| 6258/7258 | 7629 | Y4 | w/ r | -99999... ...99999 | 300 | Expected value for point no.4. |
| 6260/7260 | 7630 | X5 | w/ r | -99999... ...99999 | 400 | Individual characteristic point no. 5. |
| 6262/7262 | 7631 | Y5 | w/ r | -99999... ...99999 | 400 | Expected value for point no.5. |
| 6264/7264 | 7632 | X6 | w/ r | -99999... ...99999 | 500 | Individual characteristic point no. 6 |
| 6266/7266 | 7633 | Y6 | w/ r | -99999... ...99999 | 500 | Expected value for point no.6. |
| 6268/7268 | 7634 | X7 | w/ r | -99999... ...99999 | 600 | Individual characteristic point no. 7. |
| 6270/7270 | 7635 | Y7 | w/ r | -99999... ...99999 | 600 | Expected value for point no.7. |
| 6272/7272 | 7636 | X8 | w/ r | -99999... ...99999 | 700 | Individual characteristic point no. 8. |
| 6274/7274 | 7637 | Y8 | w/ r | -99999... ...99999 | 700 | Expected value for point no.8. |
| 6276/7276 | 7638 | X9 | w/ r | -99999... ...99999 | 800 | Individual characteristic point no. 9. |
| 6278/7278 | 7639 | Y9 | w/ r | -99999... ...99999 | 800 | Expected value for point no.9. |
| 6280/7280 | 7640 | X10 | w/ r | -99999... ...99999 | 900 | Individual characteristic point no. 10. |
| 6282/7282 | 7641 | Y10 | w/ r | -99999... ...99999 | 900 | Expected value for point no.10. |
| 6284/7284 | 7642 | X11 | w/ r | -99999... ...99999 | 1000 | Individual characteristic point no. 11. |
| 6286/7286 | 7643 | Y11 | w/ r | -99999... ...99999 | 1000 | Expected value for point no.11. |
| 6288/7288 | 7644 | X12 | w/ r | -99999... ...99999 | 1100 | Individual characteristic point no. 12. |

| | | | | | | |
|-----------|------|-----|---------|-----------------------|------|---|
| 6290/7290 | 7645 | Y12 | w/ r | -99999... ...99999 | 1100 | Expected value for point no.12. |
| 6292/7292 | 7646 | X13 | w/ r | -99999... ...99999 | 1200 | Individual characteristic point no. 13. |
| 6294/7294 | 7647 | Y13 | w/ r | -99999... ...99999 | 1200 | Expected value for point no.13. |
| 6296/7296 | 7648 | X14 | w/ r | -99999... ...99999 | 1300 | Individual characteristic point no. 14. |
| 6298/7298 | 7649 | Y14 | w/ r | -99999... 99999 | 1300 | Expected value for point no.14. |
| 6300/7300 | 7650 | X15 | w/ r | -99999... ...99999 | 1400 | Individual characteristic point no. 15. |
| 6302/7302 | 7651 | Y15 | w/ r | -99999... ...99999 | 1400 | Expected value for point no.15. |
| 6304/7304 | 7652 | X16 | w/ r | -99999... ...99999 | 1500 | Individual characteristic point no. 16. |
| 6306/7306 | 7653 | Y16 | w/ r | -99999... ...99999 | 1500 | Expected value for point no.16. |
| 6308/7308 | 7654 | X17 | w/ r | -99999... ...99999 | 1600 | Individual characteristic point no. 17. |
| 6310/7310 | 7655 | Y17 | w/ r | -99999... ...99999 | 1600 | Expected value for point no.17. |
| 6312/7312 | 7656 | X18 | w/ r | -99999... ...99999 | 1700 | Individual characteristic point no. 18. |
| 6314/7314 | 7657 | Y18 | w/ r | -99999... ...99999 | 1700 | Expected value for point no.18. |
| 6316/7316 | 7658 | X19 | w/ r | -99999... ...99999 | 1800 | Individual characteristic point no. 19. |
| 6318/7318 | 7659 | Y19 | w/ r | -99999... ...99999 | 1800 | Expected value for point no.19. |
| 6320/7320 | 7660 | X20 | w/ r | -99999... ...99999 | 1900 | Individual characteristic point no. 20. |
| 6322/7322 | 7661 | Y20 | w/ r | -99999... ...99999 | 1900 | Expected value for point no.20. |

| | | | | | | |
|-----------|------|-----------|---------|-----------------------|------|--|
| 6324/7324 | 7662 | X21 | w/ r | -99999... ...99999 | 2000 | Individual characteristic point no. 21. |
| 6326/7326 | 7663 | Y21 | w/ r | -99999... ...99999 | 2000 | Expected value for point no.21. |
| 6328/7328 | 7664 | OvrIn Lo | w/ r | -99999... ...99999 | 0 | Input signal threshold value for lower overflow |
| 6330/7330 | 7665 | OvrIn Hi | w/ r | -99999... ...99999 | 20 | Input signal threshold value for upper overflow |
| 6332/7332 | 7666 | OvrOutLo | w/ r | -24...24 | 0 | Lower output overflow |
| 6334/7334 | 7667 | OvrOutHi | w/ r | -24...24 | 0 | Upper output overflow |
| 6336/7336 | 7668 | Comp. Val | w/ r | -99999... ...99999 | 0 | Terminal temperature or resistance of cords (depending on the selected type of input) in case of selecting the manual compensation transducer mode |

Table 41

| Value located in two following 16 bit registers. These registers contain identical data as 32 bit registers from 8000... range | Value located in 32 bit registers | Name | Write (w) / Read (r) | Unit | Name value |
|--|-----------------------------------|------|----------------------|------|--|
| 8100/8200 | 8000 | | w/r | | Value of the first read out by the transducer working in Master or Monitor RS-485 interface mode |
| 8102/8202 | 8001 | | w/r | | Value of the 2-th read out by the transducer working in Master or Monitor RS-485 interface mode |
| 8104/8204 | 8002 | | w/r | | Value of the 3-th read out by the transducer working in Master or Monitor RS-485 interface mode |
| 8106...8197/ 8206...8297 | 8003... ...8049 | | w/r | | Value of the n-th read out by the transducer working in Master or Monitor RS-485 interface mode |
| 8198/8298 | 8049 | | w/r | | Value of the 50-th read out by the transducer working in Master or Monitor RS-485 interface mode |

5.9.6. Read-only registers

Table 42

| Register address (16 bit registers) | Write (w)/ read (r) | Range | Description | | |
|--|---------------------|---|--|----|---|
| 4300 | r | 0...9999 | Firmware version * 100 | | |
| 4301 | r | 0...65535 | Transducer status 1. Describes the current transducer status. The consecutive bits represent a given event. Bit set to 1 means that the event has taken place. Events can only be cleared. | | |
| | | | Bit15 | 31 | Loss of calibration parameters |
| | | | Bit14 | 30 | RTC – loss of presets – battery error |
| | | | Bit13 | 29 | Clock – change of winter/summer time |
| | | | Bit12 | 28 | No communication with data memory |
| | | | Bit11 | 27 | Wrong settings |
| | | | Bit10 | 26 | Default settings have been restored |
| | | | Bit9 | 25 | Measurement range overflow |
| | | | Bit8 | 24 | Error in communication with internal archive memory |
| | | | Bit7 | 23 | Archive parameters error |
| | | | Bit6 | 22 | ADC converter error |
| Bit5 | 21 | 100% use of the internal memory archive | | | |

| | | | | | |
|------|----------------------|-----------|--|---|---|
| | | | Bit4 | 20 | Default settings must be restored after firmware update |
| | | | Bit3 | 19 | Wrong configuration of the individual characteristic |
| | | | Bit2 | 18 | Settings have been read from file on the SD/SDHC card |
| | | | Bit1 | 17 | Wrong settings file or file is missing |
| | | | Bit0 | 16 | not used |
| 4302 | r | 0...65535 | Transducer status 2. Describes the current transducer status. The consecutive bits represent a given event. Bit set to 1 means that the event has taken place. Events can only be cleared. | | |
| | | | Bit15 | not used | |
| | | | Bit14 | not used | |
| | | | Bit13 | not used | |
| | | | Bit12 | not used | |
| | | | Bit11 | not used | |
| | | | Bit10 | not used | |
| | | | Bit9 | not used | |
| | | | Bit8 | not used | |
| | | | Bit7 | not used | |
| | | | Bit6 | Analog output overflow management switched on | |
| | | | Bit5 | LED2 – Alarm 2 indication | |
| | | | Bit4 | LED1 – Alarm 1 indication | |
| | | | Bit3 | not used | |
| Bit2 | not used | | | | |
| Bit1 | Alarm 2 relay status | | | | |
| Bit0 | Alarm 1 relay status | | | | |

| | | | | |
|------|---|-------|--|--|
| 4303 | r | 0...5 | Status of the SD/SDHC memory card or file system internal memory | |
| | | | Value | Description |
| | | | 0 | No card inserted or internal file system memory error |
| | | | 1 | Card inserted, but not mounted (unmounted) or internal file system memory error. |
| | | | 2 | Card inserted, but unmounted or internal file system memory error. |
| | | | 3 | Card is mounted but protected against writing |
| | | | 4 | Card inserted and mounted successfully or internal file system memory is ready for operation |
| | | | 5 | Card inserted and mounted successfully, but memory is full or file system memory is full. |
| 6 | Card installation in progress or internal file system memory initialization in progress | | | |
| 4304 | r | | Manufacturing status 1 | |
| | | | Bit15 ... Bit0 | 16 least significant bits of the serial number(serial number consists of 21 bits (registers 4304, 4305)and has the following structure: bits 21...16 – year (0...63) – in register 4305 bits 15...12 – month (0...12) bits 11...0 – consecutive number (1...4095) |
| 4305 | r | | Manufacturing status 2 | |
| | | | Bit15 ... Bit6 | RESERVED |
| | | | Bit5 ... Bit0 | bits 21...16 of the serial number – year (0...63) |

| | | | |
|--------------------|---|----------|---|
| 4306 | r | | RESERVED |
| 4307 | r | 0...8192 | Memory page specifying the beginning of the internal archive |
| 4308 | r | 0...8192 | Memory page specifying the end of the internal archive |
| 4309 | r | 0...527 | Byte specifying the beginning of the archive. Value in the register specifies from which byte of the archive beginning page the archive beginning is. |
| 4310 | r | 0...527 | Byte specifying the end of the archive. Value in the register indicates the following byte after which the next archive record will be written. |
| 4311... ...4322 | r | 0...15 | RESERVED |
| 4323 | r | 0...9999 | Bootloader version * 100 |

Table 43

| Value located in two following 16 bit registers. These registers contain identical data as 32 bit registers from 7500... range | Value located in 32 bit registers | Name | Write (w) /read (r) | Unit | Description |
|--|-----------------------------------|----------------------|---------------------|------|--|
| 6000/7000 | 7500 | Identifier | r | - | Constant defining the device. Value "193" means P30U transducer. |
| 6002/7002 | 7501 | Status | r | - | Register describes the current transducer status - value of 4302 register "Status no 2". |
| 6004/7004 | 7502 | Analog output state | r | % | Register specifies analog output percentage state. |
| 6006/7006 | 7503 | Minimum | r | - | Minimum value of the displayed value |
| 6008/7008 | 7504 | Maximum | r | - | Maximum value of the displayed value |
| 6010/7010 | 7505 | Displayed value | r | - | Current displayed value |
| 6012/7012 | 7506 | Current time | r | - | Current time |
| 6014/7014 | 7507 | Date - year | r | YYYY | Current date – year |
| 6016/7016 | 7508 | Month, day | r | MMDD | Current date – month, day |
| 6018/7018 | 7509 | Wypełnienie archiwum | r | % | Current use state of the internal archive memory |

| | | | | | |
|--------------------------------------|----------------|---------------------------|---|----|---|
| 6020/7020 | 7510 | Measured value | r | - | Value currently measured on the input, not calculated using individual characteristic or mathematical functions |
| 6022/7022 | 7511 | Cold junction temperature | r | °C | Cold junction temperature - temperature of transducer terminals used for thermocouples temperature compensation |
| 6024/7024 | 7512 | Second displayed value | r | | Value displayed at the lower line of the LCD display – value of any transducer register |
| 6026/7026 | 7513 | | r | | Free space on the SD/SDHC card or on the internal file system memory (kB), “-1” means card is unmounted (memory error) |
| 6028/7028 | 7514 | | r | | Total capacity of the SD/SDHC card or the internal file system memory (kB), “-1” means card is unmounted (memory error) |
| 6030... 6033/ /7030... 7033 | 7515.. 7516 | | r | - | RESERVED |
| 6034/7034 | 7517 | Analog value | r | - | Value controlling the transducer analog output |
| 6036... 6045/ /7036... 7045 | 7518.. 7522 | | | | RESERVED |
| 6046/7046 | 7523 | Minimum - date | r | - | Date of the minimum value occurrence on the input in YYM-MDD format (e.g. “130416” means 2013-04-16) |
| 6048/7048 | 7524 | Maximum - date | r | - | Date of the maximum value occurrence on the input in YYMMDD format |

| | | | | | |
|--------------------------------------|----------------------------|-------------------|---|---|--|
| 6050/7050 | 7525 | Minimum - time | r | - | Time of the minimum value occurrence on the input in HH.MMSS format (e.g. "9.5405" means 09:54:05 o'clock) |
| 6052/7052 | 7526 | Maximum - time | r | - | Time of the maximum value occurrence on the input in HH.MMSS format |
| 6054/7054 | 7527 | | r | - | Measured value after operation of individual characteristic and then mathematical function |
| 6056... 6067/ /7056... 7067 | 7528... 7533 | | | | RESERVED |
| 6068/7068 | 7534 | Status no 1 | r | - | Value of 4301 register represented as floating point value |
| 6070/7070 | 7535 | Status no 1 | | | Value of 4302 register represented as floating point value |
| 6072... 6075/ /7072... 7075 | 7536... 7537 | | r | - | RESERVED |

5.10. 10/100-BASE-T Ethernet interface

P30U transducers in P30U-X2XXXXXX manufacturing variant are equipped with an Ethernet interface enabling connection of the transducer (using RJ45 socket) to the local or global network (LAN or WAN) and using network services implemented in the transducer: WWW server, FTP server, TCP/IP Modbus slave. To use transducer's network services, configure parameters in Ethernet transducer group. Standard transducer Ethernet parameters have been shown in table 17. Transducer's IP address is the basic parameter – by default 192.168.1.30 – which must be unique within the network that the device is being connected to. The IP Address can be assigned to the transducer automatically by the DHCP server in the network, if the address downloading via DHCP option is switched on: Ethernet → DHCP → On. If the DHCP service is switched off, the transducer will operate with the default IP address enabling the user to change the IP address e.g. via transducer menu. Each transducer Ethernet parameter change requires accepting parameter changes, e.g. in menu Ethernet → ReInitEt → Yes or by entering "1" in register 4099. After accepting changes, the Ethernet interface will be reinitiated according to new parameters – all Ethernet interface services will be restarted.

5.10.1. Connecting 10/100-BASE-T Ethernet interface

To obtain access to Ethernet services, it is required to connect the transducer to the network via RJ45 socket located in the front section of the transducer, operating according to TCP/IP protocol.

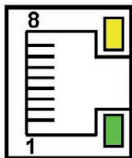

Fig.30. View and pin order of transducer RJ45 socket

Description of transducer RJ45 socket LEDs:

- yellow LED – switched on when the transducer is properly connected to the Ethernet 100 Base-T network, switched off when the transducer is not connected to the network or is connected to 10-Base-T network
- green LED – Tx/Rx, switched on when the transducer transmits and receives data, flashes randomly, when no data is transmitted it is constantly switched on

To connect the transducer to network, the following twisted pairs are recommended:

- U/FTP – each twisted pair foiled separately
- F/FTP – each twisted pair foiled separately and additionally cable foiled,
- S/FTP (earlier SFTP) – each twisted pair foiled separately and additionally cable braided,
- SF/FTP (earlier S-STP) – each twisted pair foiled separately and additionally cable foiled and braided,

Twisted pair according to European standard EN 50171, at minimum: class D (category 5) – for fast local networks, includes applications operating at up 100 MHz frequency bandwidth. The connection description has been provided in table 44. Use category 5 STP (shielded) twisted pair cabling with RJ-45 connector with color conductors (according to table 44) meeting the following standard:

- EIA/TIA 568A for both connectors using the straight connection of the P30U to the network hub or switch,
- EIA/TIA 568A for the first connector and EIA/TIA 568B for the second connector using the crossover connection, used, among others, in the case of direct connection of the P30U transducer to the PC.

Table 44

| Conductor no. | Signal | Conductor color acc. to standard | |
|---------------|--------|----------------------------------|--------------|
| | | EIA/TIA 568A | EIA/TIA 568B |
| 1 | TX+ | white/green | white/orange |
| 2 | TX- | green | orange |
| 3 | RX+ | white/orange | white/green |
| 4 | EPWR+ | blue | blue |
| 5 | EPWR+ | white/blue | white/blue |
| 6 | RX- | orange | green |
| 7 | EPWR- | white/brown | white/brown |
| 8 | EPWR- | brown | brown |

5.10.2. WWW server

The P30U transducer provides its own WWW server enabling remote monitoring of measured values and remote configuration as well as reading the transducer status. In particular, the website enables the following:

- receiving information about the device (serial number, manufacturing variant code, firmware version, bootloader version, variant (standard or special manufacturing variant),
- viewing current measurement values
- reading device status,
- selecting website language.

To access the WWW server, user must enter the transducer's IP address in the internet browser, e.g.: <http://192.168.1.30> (where 192.168.1.30 is the defined transducer's address). Port "80" is the standard WWW server port. The port server can be changed by the user.

Note: The website requires a browser with JavaScript switched on that is compatible with XHTML 1.0 (all leading browsers, Internet Explorer version 8 and higher).

5.10.2.1. Website general view

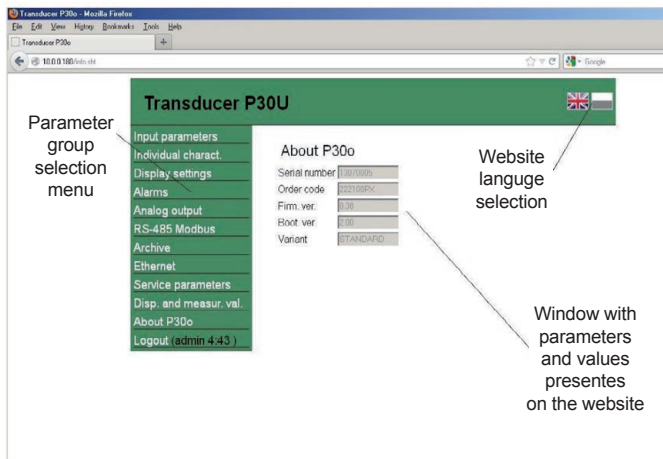

Fig.31. View of transducer's website

5.10.2.2. WWW user selection

The transducer has two user accounts for the WWW server protected with individual passwords:

- user: „**admin**“, password: „**admin**“ - configuration and viewing parameter access
- user: „**user**“, password: „**pass**“ - only viewing parameter access.

Writing the transducer's IP address in the browser, e.g. <http://192.168.1.30>, will start display the log in window. User must enter name and password.

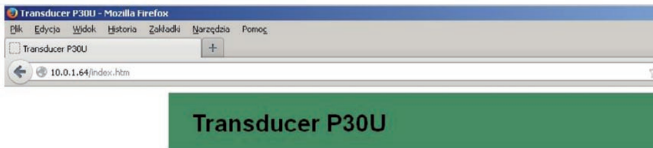

Login

Username

Password

Fig.32. View of the transducer's WWW server log in window

WWW server user names cannot be changed, but the user passwords can be changed for every user. It is recommended to change the passwords for safety reasons. Password can be changed only through the website in "Ethernet" parameters group. Passwords consist of 8 characters maximum. If user will lose password and will not be able to use the WWW server, default settings of the Ethernet interface should be restored, e.g. using menu: Ethernet → EthStdPa → Yes or enter "1" in register 4080. All default Ethernet interface parameters (see table 17) and WWW server user passwords will be restored:

user „**admin**” → password: „**admin**” ;

user „**user**” → password „**pass**”.

After logging into the WWW server, a 5 minute session is opened. After 5 minutes, the user is automatically logged out of the WWW server. Changing a parameter group renews the WWW session expiry time.

5.10.3. FTP server

FTP protocol has been implemented in P30 transducers. The transducer operates in a server FTP mode and enables clients access to the transducer's internal file system memory. Files can be accessed by a PC, tablet with an installed FTP client software or with another device operating in FTP client mode. Port "1025" – data port and "21" – command port has been used for transmitting files via the FTP protocol. The user can change the FTP protocol ports if it's required. Please note that the ports configuration of the server and client must be identical.

The FTP client software can operate in passive or active mode. It is recommended that passive mode should be selected, because in such a case the connection is completely set up by the client (the client selects the data port). In active mode, the server selects the data port, e.g. port "1025". For transmitting files with the transducer, the maximum of one simultaneous connection can be used, therefore the maximum number of connections in the client program should be limited to "1".

5.10.3.1. FTP user selection

The transducer has two user accounts for the FTP server protected with individual passwords:

- user: „**admin**“, password: „**admin**“ - writing and reading file access
- user: „**user**“, password: „**passftp**“ - only reading file access

FTP server user names cannot be changed, but the user passwords can be changed for every user. It is recommended to change the passwords for safety reasons. Password can be changed only through the website in the "Ethernet" parameters group. Passwords consist of 8 characters maximum. If user will lose password and will not be able to use the FTP server, default settings of the Ethernet interface should be restored, e.g. using menu: Ethernet → EthStdPa → Yes or enter "1" in register 4080.

All default Ethernet interface parameters (see table 17) and FTP server user passwords will be restored:

user „**admin**” → password: „**admin**” ;

user „**user**” → password „**passftp**”.

An internet browser is a basic FTP server client. Enter the transducer’s IP address with “ftp” prefix. <ftp://192.168.1.30> as a browser address and download archive files directly from the internet browser.

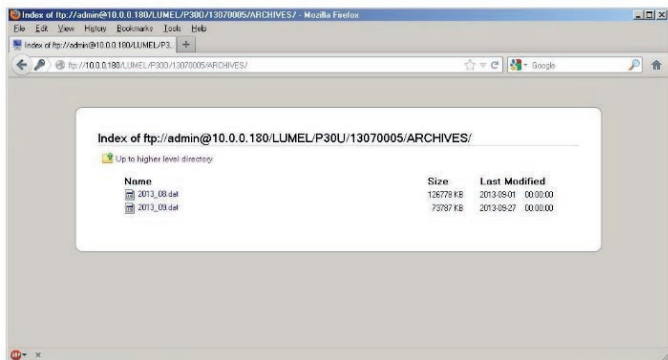

Fig.33. View of an FTP session opened in a browser window

5.10.4. TCP/IP Modbus

P30U transducers enable access to internal registers using the Ethernet interface and TCP/IP Modbus Slave protocol. The functions of Modbus protocol and structure of registers have been discussed in section 5.9.3-5.9.6. It is required to set a unique IP address for the transducer and to set connection parameters specified in table 45 to set up the connection.

Table 45

| Symbol | Description | Default value |
|----------------------|---|----------------------|
| Addr _{mTCP} | Device address for TCP/IP Modbus protocol | 1 |
| Port _{Mbus} | TCP Modbus port number | 502 |
| Time _{Mbus} | TCP/IP Modbus service closing time [s] | 60 |
| no. c. TCP | Maximum number of simultaneous connections with TCP/IP Modbus | 4 |

The device address (Ethernet → Addr_{mTCP}) is the device address for TCP/IP Modbus protocol and does not correspond to the address value for RS-485 Modbus protocol (Mbus₄₈₅ → Adres). If Addr_{mTCP} transducer parameter is set to “255”, the transducer will bypass the address analysis in the Modbus protocol frame (broadcast mode).

6. ACCESSORIES

For the transducers in P30U-X1XXXXXX variants that support SD/SDHC cards user can order an additional industrial SD card with the capacity adapted to the user's needs according to the table below. **It is not recommended to use consumer grade cards** due to significant deviations of their parameters and their low durability.

Table 46

| Item | Ordering code | Capacity |
|------|---------------|----------|
| 1 | 0923-611-193 | 1 GB |
| 2 | 0923-611-194 | 2 GB |

7. ERROR CODES

The various error messages can be displayed during transducer operation. The table below shows a list of possible error codes and their causes, including recommended remedial actions.

Table 47

| Message | Description |
|---------------------|--|
| Err. FRM Service | Calibration parameters memory error – send the transducer to the service, the message prevents measured values from being displayed |
| Err. DF | Internal archive memory error – archiving capability is lost, the transducer can operate, consider sending the transducer to a service; the message does not prevent measured values from being displayed, message is displayed in cycles. |

| | |
|------------------|--|
| Err. CAL | Calibration parameters lost – send the transducer to a service, the message does not prevent measured values from being displayed, message is displayed in cycles. |
| Err Batt Service | Real time clock battery low voltage – loss of real time clock presets after a power loss, the transducer can operate, consider sending the transducer to a service to replace the battery; the message does not prevent measured values from being displayed, message is displayed in cycles. Changing date or hour settings switches of that message. |
| Err. PAR | Parameter error – restore default settings, do not operate the transducer until default settings are restored, the message does not prevent measured values from being displayed, message is displayed in cycles. |
| Err Ind | Wrong configuration of individual characteristic parameters, the transducer can operate – individual characteristic function does not work, the message does not prevent measured values from being displayed, message is displayed in cycles. |
| Error Par. File | Reading configuration from file stored on an external SD/SDHC card or on the internal file system memory unsuccessful – file is missing or corrupted, the transducer can be operated, the message does not prevent measured values from being displayed, message is displayed in cycles for about 20 seconds. |

8. TECHNICAL DATA

Inputs:

Table 48

| Input type | Nominal measuring range | Maximum measurement range | Multiplicity of narrowing of the scope (from the best. class) | Measurement class |
|---------------------|-------------------------|---------------------------|---|-------------------|
| Vol tage -10. . 10V | -10...10V | -12...12 V | 4 | 0.1 |
| Vol tage -24. . 24V | -24...24V | -28...28 V | 5 | |
| Current -24. . 24mA | -20...20 mA | -24...24 mA | 10 | |
| Resi stance 400 Ω | 0...400 Ω | 0...420 Ω | 4 | |
| Resi stance 2000 Ω | 0...2000 Ω | 0...2050 Ω | 2 | |
| Resi stance 5500 Ω | 0...5500 Ω | 0...5550 Ω | 2 | |
| Pt100 | -200...850 °C | -205...855 °C | 5 | |
| Pt250 | -200...600 °C | -205...605 °C | 4 | |
| | -200...850 °C | -205 ... 855 °C | 3 | |
| Pt500 | -200...180 °C | -205 ... 185 °C | 3 | |
| | -200...850 °C | -205 ... 855 °C | 3 | |
| Pt1000 | -200...250 °C | -205 ... 255 °C | 4 | |
| | -200...850 °C | -205 ... 855 °C | 2 | |
| Ni 100 | -60...180 °C | -65 ... 185 °C | 1 | |
| Ni 1000 | -60...150 °C | -65 ... 155 °C | 2 | |
| Ni 100-LG | -60 ...180 °C | -65 ... 185 °C | 1 | |
| Ni 1000-LG | -60...180 °C | -65 ... 185 °C | 2 | |
| Cu100 | -50...180 °C | -55 ... 185 °C | 1 | |

| | | | | |
|----------------|--|------------------|---|-----|
| Voltage mV | -5...20 mV | -6 ... 21 mV | 1 | 0.1 |
| | -75...75 mV | -80 ... 80 mV | 4 | |
| | -200...200 mV | -210 ... 210 mV | 4 | |
| Thermocouple J | 0...400 °C | -20 ... 420 °C | 1 | |
| | -200...1200 °C | -220 ... 1210 °C | 2 | |
| Thermocouple K | 0...400 °C | -20 ... 420 °C | 1 | |
| | -200...1370 °C | -280 ... 1382 °C | 2 | |
| Thermocouple S | 0...1760 °C | -55 ... 1775 °C | 2 | 0.5 |
| Thermocouple N | -20...420 °C | -50 ... 450 °C | 1 | 0.2 |
| | -200...1300 °C | -240 ... 1350 °C | 1 | |
| Thermocouple E | -40...260 °C | -50 ... 280 °C | 1 | |
| | -200...1000 °C | -210 ... 1010 °C | 2 | |
| Thermocouple R | 0...1760 °C | -55 ... 1765 °C | 2 | 0.5 |
| Thermocouple T | -200...400 °C | -210 ... 410 °C | 1 | 0.2 |
| Thermocouple B | 400...1800 °C | 390 ...1820 °C | 1 | 0.5 |
| RS-485 | In RS-485 mode transducer gives measured value from register 8000 - value read or written using RS-485 interface which works in Slave, Monitor, Master modes | | | |

- sample rate
 - input type: Vol tage 10 V,
 - Vol tage -24. . 24V, Prad -24. . 24mA 80 ms
 - other inputs 160 ms

Output:

- analog output - programmable, insulated galvanically, current (0/4...20 mA, load resistance $\leq 500 \Omega$) or voltage (0...10 V, load resistance $\geq 500 \Omega$),
- analog output accuracy class 0.1;
- analog output conversion time < 40 ms
- relay – 1 or 2 relays; voltage free contacts, normally open, maximum load capacity 5 A 30 V d.c. or 250 V a.c.
- digital – RS-485 interface:
 - transmission protocol: Modbus RTU
 - transmission rate: 4800, 9600, 19200, 38400, 57600, 115200, 230400, 256000 [b/s].
 - address: 1...247
 - mode: 8N2, 8E1, 8O1, 8N1
 - maximum time to start response 200 ms¹
- auxiliary power supply (option) 24 V d.c. / 30 mA
- clock accuracy 1s/24 h

Power consumption < 6 VA

Weight < 0.25 kg

Dimensions 120 x 45 x 100 mm

Mounting 35 mm rail acc. to EN 60715

Insured protection grade by the housing

| | |
|--|------|
| housing-side (variant incompatible with SD/SDHC cards) | IP40 |
| housing-side (variant compatible with SD/SDHC cards) | IP30 |
| terminals-side | IP20 |

Display alphanumeric LCD display 2x8 characters
with LED backlight

Warm-up time 15 min

Recording

Recording into the internal 4 MB memory (max. 534,336 records) – recording with time stamp, for variants compatible with SD/SDHC - possibility to automatically writing internal archive into SD/SDHC cards.

Reference conditions and nominal operational conditions

- supply voltage 85..253 V d.c./a.c.(40..400 Hz) or 20..40 V a.c.
(40..400 Hz), 20...60 V d.c.
- ambient temperature -25..23..+55 °C
- storage temperature -30..+70 °C
- humidity 25..95 % (condensations not acceptable)
- operating position any

¹ The maximum time to start response can extend to 500 ms during data writing into the SD/SDHC card or in the internal file system memory

Additional errors:

- due to temperature variations:
 - for the analog outputs 50% of the out. class / 10 K
 - for the measuring inputs 100% of the input. class / 10 K
- compensation of cold junction temperature changes $\leq 1^{\circ}\text{C}$
- compensation of wire resistance changes (temperature measurement) $\leq 0.2^{\circ}\text{C}$
- compensation of wire resistance changes (resistance measurement) $\leq 0,05 \Omega$

Input parameters

- resistance of the voltage input -10. . . 10V, -24, . . . 24V:
> 1 M Ω
- resistance of the voltage input Voltage mV, Thermocouple e:
>100 k Ω
- resistance of the current input -24. . . 24 mA: 12 \pm 1 Ω %
- current flowing through a thermometric resistor < 0,2 mA
- resistance of cords connecting a thermometric resistor with the transducer: < 10
- resistance of external measuring circuits for voltage and thermocouple inputs <100 Ω

Long-term overload capability

- thermocouples, thermoresistors 1,1 Xn
- voltage, current and resistance 1,3 Xn

Insulation between circuits

- power supply acc. measuring inputs, analog outputs, RS-485 interface 2,2 kV
- measuring inputs acc. analog output, RS-485 interface 1 kV

Standards met by the transducer

Electromagnetic compatibility:

- disturbance immunity acc. to EN 61000-6-2
- disturbance emission acc. to EN 61000-6-4

Security requirements acc. to EN 61010-1

- isolation between circuits basic,
- installation category III
- pollution grade 2
- phase-to-earth working voltage: 300 V for the power supply circuit and 50 V for other circuits
- altitude above sea level < 2000 m

9. ORDERING CODE

Table 49

| P30U transducer- | X | X | X | X | XX | X | X |
|---|---|---|---|---|----|----|----|
| Analog output: | | | | | | | |
| current (0/4...20 mA) | 1 | | | | | | |
| voltage (0...10 V) | 2 | | | | | | |
| Additional equipment: | | | | | | | |
| without any | | 0 | | | | | |
| with external SD/SDHC slot | | 1 | | | | | |
| With Ethernet interface and internal file system memory | | 2 | | | | | |
| Additional output: | | | | | | | |
| relay (normally opened) , 5 A 30 V d.c., 250 V a.c. | | | 1 | | | | |
| supply 24 V d.c. / 30 mA | | | 2 | | | | |
| Supply: | | | | | | | |
| 85...253 V a.c./d.c. | | | | 1 | | | |
| 20...40 V a.c., 20...60 d.c. | | | | | 2 | | |
| Version: | | | | | | | |
| standard | | | | | | 00 | |
| custom-made* | | | | | | | XX |
| Language: | | | | | | | |
| Polish | | | | | | | P |
| English | | | | | | | E |
| other* | | | | | | | X |
| Acceptance tests: | | | | | | | |
| without extra requirements | | | | | | | 0 |
| with an extra quality inspection certificate | | | | | | | 1 |
| according to customer's request* | | | | | | | X |

* after consultation with manufacturer

Example of Order:

The Code **P30U-112100E1** means a transducer in a standard version with a current analog output, supporting external SD/SDHC cards, with 24 V/30 mA power output, 85...235 V a.c./d.c. power supply, in English language version and a Quality Control Certificate.

P30U-09B



LUMEL S.A.

ul. Słubicka 1, 65-127 Zielona Góra, Poland

Tel.: (48-68) 45 75 100

Fax: (48-68) 45 75 508

e-mail: lumel@lumel.com.pl

<http://www.lumel.com.pl>

Export Department:

Tel.: (48-68) 45 75 302

Fax: (48-68) 32 54 091

e-mail: export@lumel.com.pl