

GM3

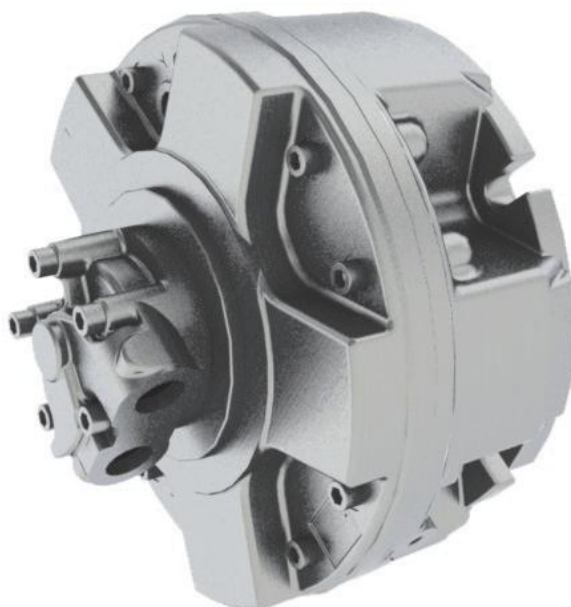

PERFORMANCES TABLE
TABELLA DELLE PERFORMANCE

GM3		350★	425	500	600★	700★	800	900	1000
Displacement / Cilindrata	cm ³ /rev	352	426	486	595	690	792	873	987
Bore / Alesaggio	mm	40	44	47	52	56	60	63	67
Stroke / Corsa	mm	56	56	56	56	56	56	56	56
Specific torque / Coppia spec.	Nm/bar	5,49	6,64	7,58	9,28	10,80	12,40	13,60	15,40
Cont. Pressure / Press. Cont.	bar	250	250	250	250	250	250	250	250
Peak pressure / Press. Picco	bar	450	425	425	400	350	350	350	280
Cont. speed / Velocità Cont.	rpm	525	500	450	450	400	400	350	300
Max. speed / Velocità Max	rpm	700	650	600	575	500	500	400	350
Peak power / Potenza picco	kW	80	80	80	80	80	80	80	80

Approximative mass / Massa approssimativa kg 86

Motor casing oil capacity / Capacità olio corpo motore l 4,5

Max casing pressure / Pressione max. in carcassa	bar	5	peak picco	La pressione continua o media di lavoro va determinata in funzione della vita del motore (vita dei cuscinetti).
		1	continuous continuo	Continuous or average working pressure should be chosen in function of the required service lifetime (bearing lifetime).

DIMENSIONS

DIMENSIONI

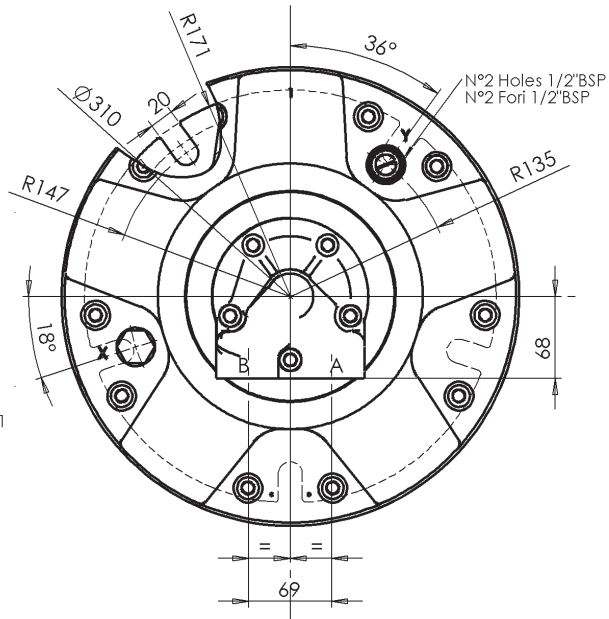
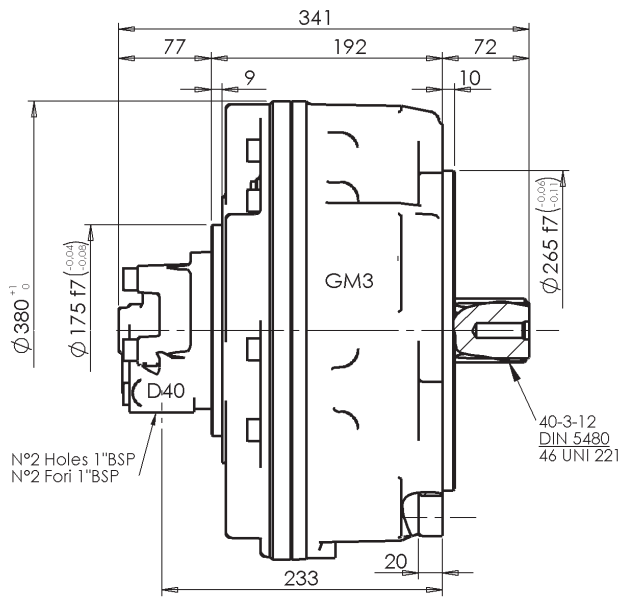

Available also GM3A completely interch. to M3 till cc. 800 - not available with splined shaft 36 UNI 221

Disponibile anche GM3A completamente intercambiabile con M3 fino a cc. 800 - non disponibile con albero calettato 36 UNI 221

SHAFTS

ALBERI

Splined DIN 5480 7
Calettato UNI 221 1

Tapered 2
Conico

Cylindrical 8
Cilindrico

Internal spline DIN 5480 9
Calett. intern. UNI 220 3

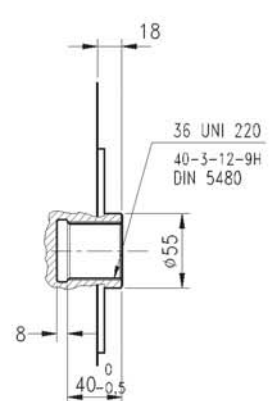
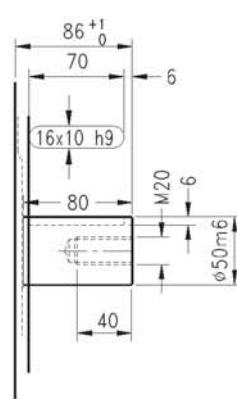
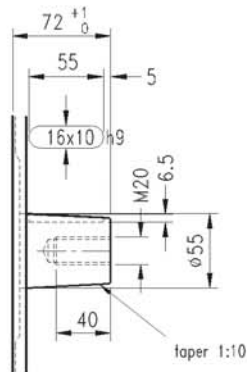
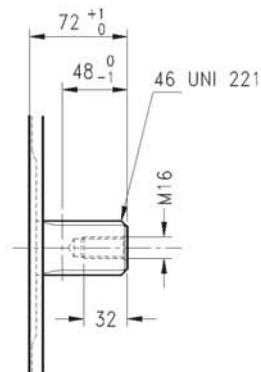

SPLINE DATA - CALETTATURE

40-3-12 DIN 5480		46 UNI 221 (8-46-54 DIN 5463)	
	d0 Ø36.0		d1 Ø46.0 ^{+0.030} / ₊₀ H7
	d1 Ø40.0 ^{+0.620} / ₊₀ H14		d2 Ø54.0 ^{+0.190} / ₊₀ H11
	d2 Ø34.0 ^{+0.160} / ₊₀ H11		A 9.0 ^{+0.028} / _{+0.013} F7
	A Ø5.25		d3 Ø46.0 ^{-0.009} / _{-0.025} g6
	da Ø28.964 H11		d4 Ø54.0 ^{-0.100} / _{-0.290} d11
	d3 Ø39.4 ⁻⁰ / _{-0.160} h11		B 9.0 ^{-0.013} / _{-0.028} f7
	d4 Ø33.4 ⁻⁰ / _{-0.620} h14		
	B Ø6.0		
	db Ø45.989 f8		

ADAPTORS
MANICOTTI

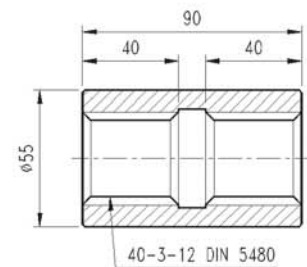

PERFORMANCE

The graphs indicate the typical performance characteristics of the 600 cc motor operating with mineral oil with viscosity 40 cSt at 50 °C.

CARATTERISTICHE

I grafici si riferiscono alle caratteristiche del motore 600 cc operando con olio minerale avente viscosità 40 cSt a 50 °C.

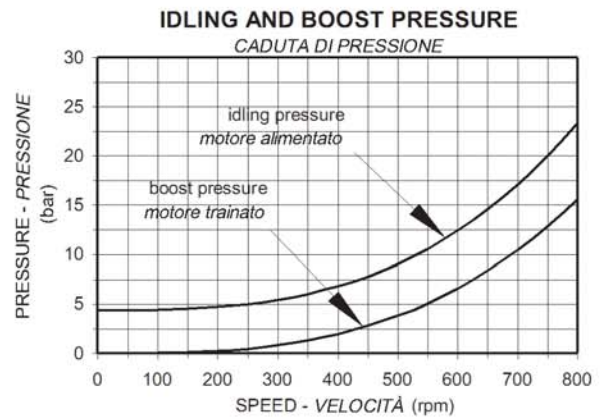
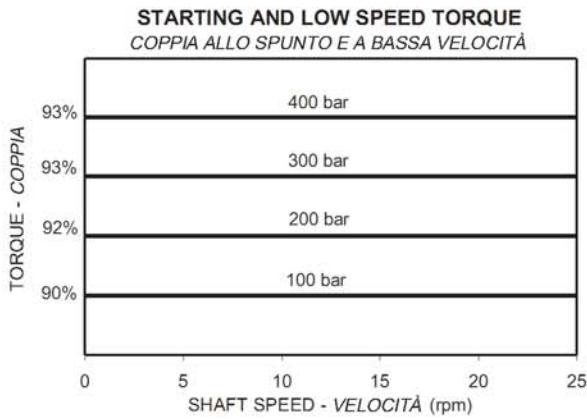
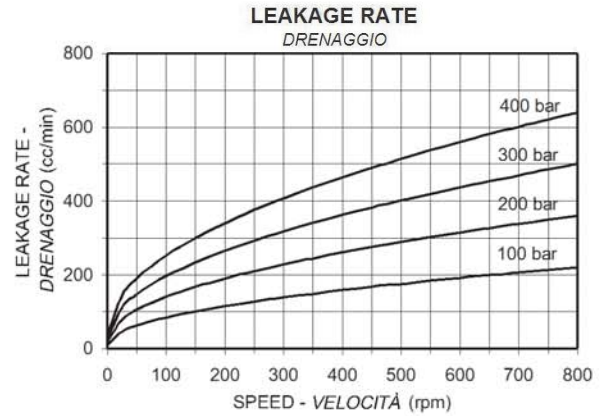
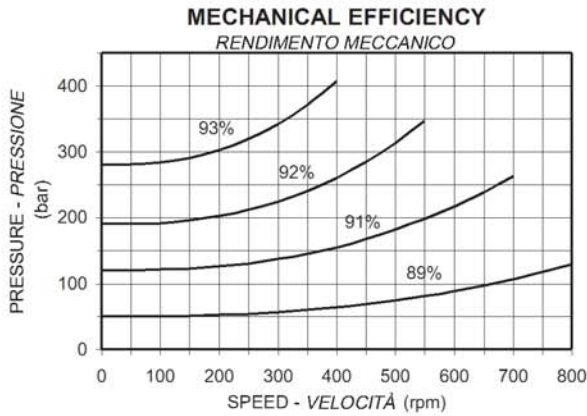

BEARING LIFETIME

The graph refers to the motor with the standard bearings. Note that the average lifetime of a bearing (B₅₀ lifetime) is approximately 5 times the B₁₀ lifetime.

VITA CUSCINETTI

Il grafico si riferisce ai motori con i cuscinetti standard. Notare che la vita media di un cuscinetto (vita B₅₀) è circa 5 volte superiore alla vita B₁₀.

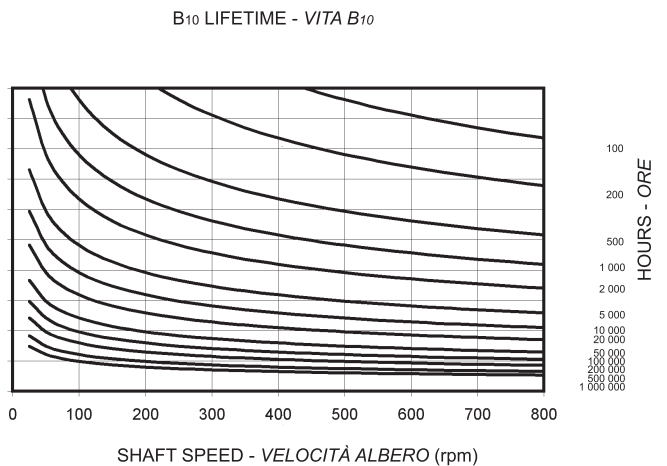
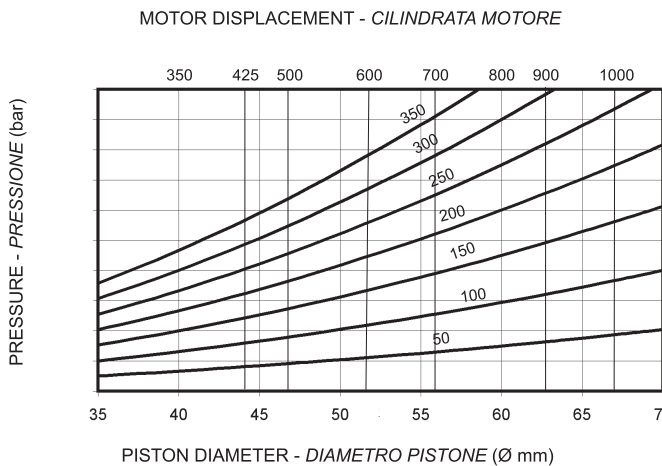

BEARING OPTIONS

Roller bearings (Standard) - The lifetime of the standard bearings is given in the lifetime graph.

Spherical roller bearing (option GP) - in the motor cover - the lifetime is approximately 5.4 times the equivalent lifetime of the standard bearing.

For longer lifetimes contact our technical department.

OPZIONI CUSCINETTI

Cuscinetti a rulli (Standard) - La vita dei cuscinetti standard è ricavabile dal grafico riportato.

Cuscinetto a rulli orientabili (opzione GP) - sul coperchio motore- questi cuscinetti hanno una durata di 5,4 volte l'equivalente vita dei cuscinetti standard.

Per una durata maggiore consultare il Ns. ufficio tecnico

ORDER CODES**CODICI D'ORDINE**

GM3 - ① ② ③ ④ + ⑤ ⑥ ; ⑦ ⑧

MOTOR CODE

1. **Nominal displacement** - see motor spec. table.

2. **Shaft option:**

- 7 = male 40-3-12 DIN 5480 (std)
- 1 = male 46 UNI 221
- 9 = female 40-3-12 DIN 5480
- 3 = female 36 UNI 220
- 2 = tapered keyed
- 8 = cylindrical keyed

3. **Bearings:**

- no code = roller bearings
- GP = spherical roller bearing in the motor cover

4. **Other options:**

- U = without shaft seal
- SV = stainless steel shaft sleeve corr. protect. for shaft seal
- A = high pressure shaft seal (5 bar cont., 15 bar peak)
- V = Vytan seals
- I = case press. relief valve 3 bar

DISTRIBUTOR CODE see page *

5. **Distributor:** D40 standard

6. **Tachometer:** K = predisposed for tachometer
J = with tachometer coupling

ASSEMBLY CODES

7. **Direction of shaft rotation:** standard motors are supplied with clockwise rotation (viewed from shaft end) with flow in port A, out port B.

- R = clockwise rotation
- L = anti-clockwise rotation

8. **Distributor cover position:** see page¹⁰

- no code = position DM1
- DM . , = other position

CODICE MOTORE

1. **Cilindrata nominale** - vedi tabella cilindrate.

2. **Opzioni albero:**

- 7 = maschio 40-3-12 DIN 5480
- 1 = maschio 46 UNI 221
- 9 = femmina 40-3-12 DIN 5480
- 3 = femmina 36 UNI 220
- 2 = conico con chiavetta
- 8 = cilindrico con chiavetta

3. **Cuscinetti:**

- nessun codice = cuscinetti a rulli
- GP = cuscinetto a rulli di botte sul coperchio motore

4. **Altre opzioni:**

- U = senza tenuta albero
- SV = manicotto inox sull'albero protez. anticorros. per tenuta
- A = tenuta albero alta pressione (5 bar cont., 15 bar picco)
- V = Tenute in Vytan
- I = valv. sfiato 3 bar

CODICE DISTRIBUTORE vedi pagina *

5. **Distributore:** D40 standard

6. **Contagiri:** K = predisposizione per contagiri
J = con attacco contagiri

CODICI PER L'ASSEMBLAGGIO

7. **Rotazione albero:** i motori sono forniti con rotazione in senso orario (visto dal lato albero) con flusso in ingresso in port A, in uscita port B.

- R = rotazione in senso orario
- L = rotazione in senso anti-orario

8. **Posiz. coperchio distributore:** vedi pag.¹⁰

- nessun codice = posizione DM1
- DM . , = altra posizione