

# Pfannenberg Filterfan 4<sup>th</sup> Generation

- ⓓ **Montage- und Betriebsanleitung**
- ⓖⓑ **Installation- and operating instructions**
- ⓕ **Notice de montage et d'utilisation**
- ⓃⓁ **Montage- en gebruikshandleiding**
- Ⓢ **Installations och bruksanvisning**
- Ⓛ **Istruzioni di montaggio e per l'uso**
- ⓔ **Instrucciones de montaje y para uso**
- ⓇⓊⓈ **Инструкция по установке и эксплуатации**

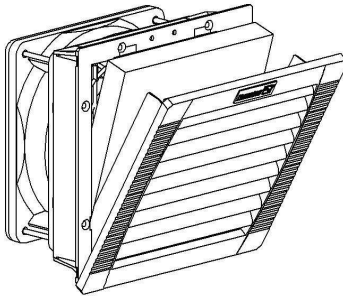

**IP54/ TYPE 12 PF/ PF EMC**

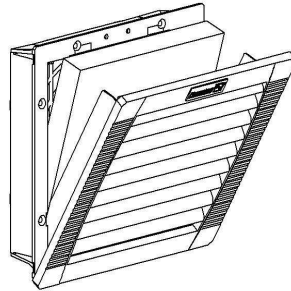

**IP54/ TYPE 12 PFA/ PFA EMC**

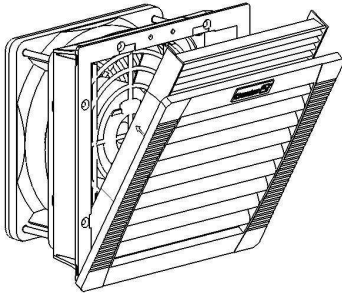

**IP55/ TYPE 12 PF/ PF EMC**

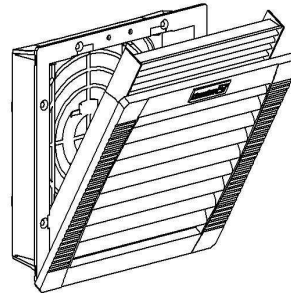

**IP55/ TYPE 12 PFA/ PFA EMC**

- ⓓ Lesen Sie diese Anweisung und bewahren Sie diese auf.
- ⓖⓑ Read and save this instruction.
- ⓕ Lisez et sauvegardez ces instructions.
- ⓃⓁ Deze instructies lezen en bewaren.
- Ⓢ Läs och spara dessa anvisningar.
- Ⓛ Legga e salvi queste istruzioni.
- ⓔ Lea y salve estas instrucciones.
- ⓇⓊⓈ Прочитайте, пожалуйста, данную инструкцию и сохраните ее

**Pfannenberg**  
ELECTRO-TECHNOLOGY FOR INDUSTRY



- (D)** Ausschnitte und Abmessungen  
**(GB)** Cut outs and dimensions  
**(F)** Découpes de montage et dimensions  
**(NL)** Uitsparingen en afmetingen

- (S)** Urklipp och dimensioner  
**(I)** Dima di foratura e dimensioni  
**(E)** Plantillas y dimensiones  
**(RUS)** Монтажные вырезы и габаритные размеры

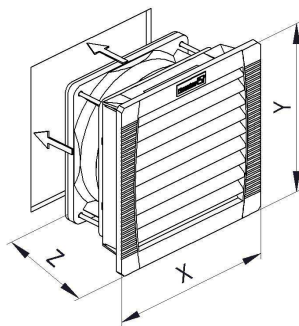
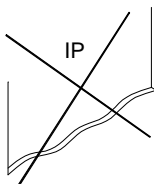
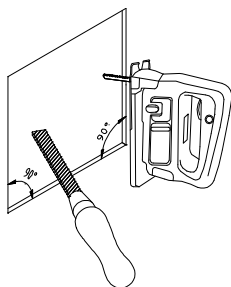
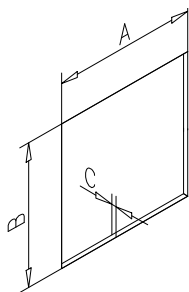

		A = B mm(inch)		X = Y mm(inch)	Z mm(inch)		
		Standard	EMC		PF		PFA
		$C \leq 2(0,08") = A_0^{+1(0,04")}$ $C > 2(0,08") \leq 3(0,12") = A^{+2(0,08") +1(0,04")}$			DC	AC	
PF 11000	PFA 10000	92(3 <sup>5</sup> / <sub>8</sub> ")	93(3 <sup>21</sup> / <sub>32</sub> ")	109(4 <sup>19</sup> / <sub>64</sub> ")	53(2 <sup>3</sup> / <sub>32</sub> ")	66(2 <sup>19</sup> / <sub>32</sub> ")	23(2 <sup>69</sup> / <sub>32</sub> ")
PF 22000	PFA 20000	125(4 <sup>29</sup> / <sub>64</sub> ")	126,5(4 <sup>63</sup> / <sub>64</sub> ")	145(5 <sup>45</sup> / <sub>64</sub> ")	69(2 <sup>23</sup> / <sub>32</sub> ")	75(2 <sup>61</sup> / <sub>64</sub> ")	31(1 <sup>7</sup> / <sub>32</sub> ")
PF 32000	PFA 30000	177(6 <sup>31</sup> / <sub>32</sub> ")	178 (7")	202(7 <sup>61</sup> / <sub>64</sub> ")	87(3 <sup>27</sup> / <sub>64</sub> ")	93(3 <sup>43</sup> / <sub>64</sub> ")	40(1 <sup>37</sup> / <sub>64</sub> ")
PF 42500	PFA 40000	223(8 <sup>25</sup> / <sub>32</sub> ")	224(8 <sup>53</sup> / <sub>64</sub> ")	252(9 <sup>59</sup> / <sub>64</sub> ")	103(4 <sup>1</sup> / <sub>16</sub> ")		44(1 <sup>47</sup> / <sub>64</sub> ")
PF 43000					103(4 <sup>1</sup> / <sub>16</sub> ")	119(4 <sup>11</sup> / <sub>16</sub> ")	
PF 65000	PFA 60000	291(11 <sup>29</sup> / <sub>64</sub> ")	292(11 <sup>1</sup> / <sub>2</sub> ")	320(12 <sup>19</sup> / <sub>32</sub> ")	157(6 <sup>3</sup> / <sub>16</sub> ")		46(1 <sup>13</sup> / <sub>16</sub> ")
PF 65000 SL					131(5 <sup>5</sup> / <sub>32</sub> ")		
PF 66000					157(6 <sup>3</sup> / <sub>16</sub> ")		
PF 67000					157(6 <sup>3</sup> / <sub>16</sub> ")		
PF 67000 SL					134(5 <sup>9</sup> / <sub>32</sub> ")		

- (D) ACHTUNG:** Nur in richtiger Einbaulage und bei Nicht-Zerstören der Dichtung ist IP54/ IP55/ Type 12 gewährleistet.  
**EMC** Funktionsgewährleistung nur bei elektrisch leitfähiger Verbindung zwischen EMV- Schirmblech und Montageausschnitt.
- (GB) CAUTION:** The degree of protection IP54/ IP55/ Type 12 cannot be guaranteed unless the correct installation position and a non-destroyed foam gasket are ensured.  
**EMC** Function cannot be guaranteed unless there is a conductive connection between the EMC-shield and the mounting cut out
- (F) ATTENTION:** IP54/ IP55/ Type 12 ne peut pas être garantie à moins qu'une position d'installation correcte et une étanchéité intacte soient assurées.  
**CEM** La fonction n'est garantie que dans le cas d'un contact électroconducteur entre la tôle de protection CEM et la découpe pour le montage.
- (NL) OPZACHTEN:** er is slechts sprake van klasse IP54/ IP55/ Type 12, als de montage en positionering precies op de voorgeschreven manier uitgevoerd is en als de afdicthing niet beschadigd is.  
**EMC** De functiegarantie geldt uitsluitend als er tussen de EMC-afscherming en de montage-uitsnijding een elektrisch geleidende verbinding bestaat.
- (S) VARNING:** IP54/ IP55/ Type 12 gäller endast vid rätt monteringsläge och vid hel packning.  
**EMC** Funktionsgarantin gäller endast under förutsättning att det finns en elektriskt ledande förbindelse mellan EMC-skärmplåten och monteringsutskäringen
- (I) ATTENZIONE:** Il grado di protezione IP54/ IP55/ Type 12 può essere garantito esclusivamente tramite una posizione di montaggio corretta e non interferendo con la garnizione die tenuta.  
**EMC** Il funzionamento è garantito solo in caso di possibilità di collegamento elettricamente conducibile fra lo schermo in lamiera EMC e l'apertura di montaggio.
- (E) PRECAUCION:** La clase de protección IP54/ IP55/ Type 12 puede ser garantizada solamente si la hunta está instalada correctamente y sin destrucción.  
**EMC** Sólo se garantiza el funcionamiento con una conexión eléctrica conductiva entre la chapa de protección EMC y el recorte de montaje.
- (RUS) Внимание:** Степень защиты IP54/ IP55/ Type 12 может быть гарантирована только при правильной установке и сохранности уплотнения.  
**EMC** Функционирование возможно при наличии токопроводящего соединения между уплотнительной лентой EMC и монтажной стеной.

- Ⓓ Elektrischer Anschluss
- ⒼⒷ Power connection
- Ⓕ Branchement électrique
- ⒸⓃ Elektrische aansluiting

- Ⓔ Elanslutning
- Ⓘ Allacciamento elettrico
- Ⓔ Conexión de energía
- ⒸⓇ Электрическое подключение

DC-12/24/48V

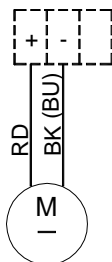

AC-24V

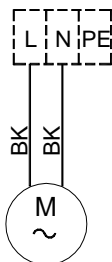

AC-230/115V

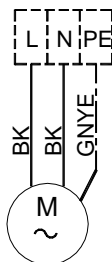

AC-230/115V

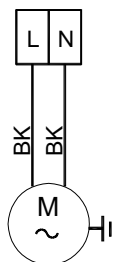

AC-230/115V

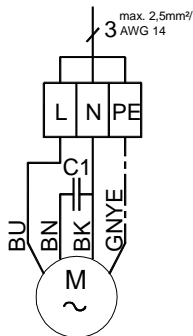

AC- 400V

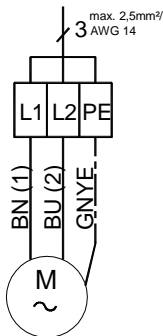



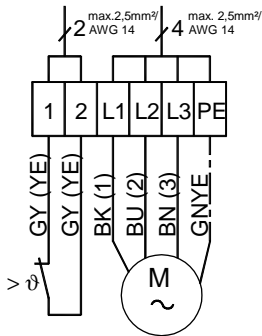

AC- 400/460V



- Ⓓ Mindestabstand zwischen Lichtbogen bildenden Bauteilen und Filter: 30,5cm (12") (UL508A sec. 22)
- ⒼⒷ Minimum distance of 30,5cm (12") between arcing parts and filters (acc. UL508A sec. 22)
- Ⓕ Distance minimale entre les pièces formant un arc et les filtres: 30,5 cm (12") (UL508A sec. 22)
- ⒸⓃ Minimum afstand tussen lichtbogen vormende componenten en filters: 30,5cm (12") (UL508A sec. 22)
- Ⓔ Minsta avstånd mellan de ljusbågsbildande delar och filtret: 30,5 cm (12") (UL508A sec. 22)
- Ⓘ Distanza minima fra gli elementi che formano l'arco e il filtro: 30,5 cm (12") (UL508A sec. 22)
- Ⓔ Distancia mínima entre los componentes del arco eléctrico y los filtros: 30,5 cm (12") (UL508A sec. 22)
- ⒸⓇ Минимальное расстояние между деталями, образующими электродугу, и фильтром: 30,5 см (12") (UL508A sec. 22)



- (D) Technische Daten  
 (GB) Technical data  
 (F) Caractéristiques Techniques  
 (NL) Technische gegevens

- (S) Tekniska data  
 (I) Dati tecnici  
 (E) Datos técnicos  
 (RU) Технические данные

	U +/- DC	U ~ 50/60 Hz * 60Hz	P	I				
	V	V	W	A				standard (EMC)
PF 11.000	12	--	2,4	0,2	-40.. + 55°C -40.. +131°F	-40.. + 70°C -40.. +158°F	6A	0,16 (0,19)
PF 11.000	24	--	2,4	0,1				
PF 11.000	48	--	2,6	0,05				
PF 11.000	--	24	12/11	0,5/0,5				
PF 11.000	--	115	12/11	0,15/0,15				
PF 11.000	--	230	12/11	0,07/0,06				
PF 22.000	12	--	5	0,42	-40.. + 55°C -40.. +131°F	-40.. + 70°C -40.. +158°F	6A	0,44 (0,49)
PF 22.000	24	--	5	0,21				
PF 22.000	48	--	5	0,1				
PF 22.000	--	24	20/20	1,05/1,02				
PF 22.000	--	115	20/20	0,235/0,23				
PF 22.000	--	230	19/18	0,12/0,18				
PF 32.000	12	--	5	0,42	-40.. + 55°C -40.. +131°F	-40.. + 70°C -40.. +158°F	6A	0,61 (0,7)
PF 32.000	24	--	5	0,21				
PF 32.000	48	--	5	0,1				
PF 32.000	--	115	20/20	0,235/0,23				
PF 32.000	--	230	19/18	0,12/0,18				
PF 42.500	12	--	6	0,5				-40.. + 55°C -40.. +131°F
PF 42.500	24	--	4,7	0,2				
PF 42.500	48	--	4,6	0,1				
PF 42.500	--	115	18/17	0,25/0,25				
PF 42.500	--	230	18/17	0,12/0,1				
PF 43.000	12	--	12	1	-40.. + 55°C -40.. +131°F	-40.. + 70°C -40.. +158°F	6A	
PF 43.000	24	--	12	0,5				
PF 43.000	48	--	12	0,25				
PF 43.000	--	115	40/40	0,5/0,5				
PF 43.000	--	230	45/39	0,32/0,26				
PF 43.000	--	400	41/38	0,13/0,13				
PF 65.000	--	115	75/90	0,66/0,8	-40.. + 55°C -40.. +131°F	-40.. + 70°C -40.. +158°F	6A	3,2 (3,43)
PF 65.000	--	230	65/80	0,3/0,36				
PF 65.000 SL	--	115	64/80	0,58/0,7	-40.. + 55°C -40.. +131°F	-40.. + 70°C -40.. +158°F	6A	3,3 (3,53)
PF 65.000 SL	--	230	64/80	0,29/0,35				
PF 66.000	--	115	110/160	0,96/1,4	-40.. + 55°C -40.. +131°F	-40.. + 70°C -40.. +158°F	6A	3,2 (3,43)
PF 66.000	--	230	115/150	0,51/0,66				
PF 66.000	--	400/460	120/155	0,26/0,25				
PF 67.000	--	115	140/195	1,23/1,71	-40.. + 55°C -40.. +131°F	-40.. + 70°C -40.. +158°F	6A	3,7 (3,93)
PF 67.000	--	230	135/215	0,59/1				
PF 67.000	--	400/460	140/170	0,35/0,425				
PF 67.000 SL	--	115	120/165	1,05/1,45	-40.. + 55°C -40.. +131°F	-40.. + 70°C -40.. +158°F	6A	3,9 (4,13)
PF 67.000 SL	--	230	127/180	0,56/0,79				
PF 67.000 SL	--	400/460	110/165	0,2/0,23				
PFA 10.000	--	--	--	--	-40.. + 55°C -40.. +131°F	-40.. + 70°C -40.. +158°F	--	0,06 (0,09)
PFA 20.000								0,12 (0,18)
PFA 30.000								0,26 (0,35)
PFA 40.000								0,46 (0,62)
PFA 60.000								0,7 (0,93)

- |    |                                       |     |                                   |
|----|---------------------------------------|-----|-----------------------------------|
| Ⓓ  | Ersatzteilbeschaffung                 | Ⓔ   | Beställning av reservdelar        |
| ⒼⒷ | Ordering spare parts                  | Ⓘ   | Fornitura delle parti di ricambio |
| Ⓕ  | Approvisionnement en pièces détachées | Ⓔ   | Adquisición de repuestos          |
| ⒸⓁ | Bestelling van onderdelen             | ⓇⓊⓈ | Приобретение запасных деталей     |

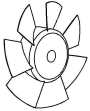
**www.filterfan.com - spareparts@pfannenberg.com**

	U +/- DC	U ~ 50/60 Hz		IP54/ TYPE 12  5x	IP 55/ TYPE 12  5x
PF 11.000	12V	-	18611000036	18611600029	--
	24V	-	18611000039		
	48V	-	18611000042		
	-	24V	18611000005		
	-	115V	18611000028		
	-	230V	18611000032		
PFA 10.000	--	--	--		
PF 22.000	12V	-	18611000025	18611600030	18611600034
	24V	-	18611000026		
	48V	-	18611000027		
	-	24V	18611000006		
	-	115V	18611000009		
	-	230V	18611000016		
PFA 20.000	--	--	--		
PF 32.000	12V	-	18611000025	18611600031	18611600035
	24V	-	18611000026		
	48V	-	18611000027		
	-	24V	18611000006		
	-	115V	18611000009		
	-	230V	18611000016		
PFA 30.000	--	--	--		
PF 42.500	12V	-	18611000037	18611600032	18611600036
	24V	-	18611000040		
	48V	-	18611000054		
	-	115V	18611000029		
	-	230V	18611000033		
PF 43.000	12V	-	18611000055	18611600032	18611600036
	24V	-	18611000056		
	48V	-	18611000057		
	-	115V	18611000012		
	-	230V	18611000019		
	-	400V	18611000022		
PFA 40.000	--	--	--		
PF 65.000	-	115V	18611000047	18611600033	18611600037
	-	230V	18611000044		
PF 66.000	-	115V	18611000048		
	-	230V	18611000045		
	-	400/460V	18611000050		
PF 67.000	-	115V	18611000049		
	-	230V	18611000046		
	-	400/460V	18611000051		
PFA 60.000	--	--	--		
PF 65.000 SL	-	115V	18611000004	--	18611600037
	-	230V	18611000001		
PF 67.000 SL	-	115V	18611000003		
	-	230V	18611000000		
	-	400/460V	18611000065		

- Ⓓ Filterwechsel / Wartung
- Ⓖᅇ Filter change / Maintenance
- Ⓕ Remplacement de la cartouche Filtrante / Entretien
- Ⓖᅇ Filter vervanging / Onderhoud

- Ⓕ Filterbyte / Underhåll
- Ⓕ Filtri di ricambio / Manutenzione
- Ⓕ Cambio de filtro / Mantenimiento
- Ⓕ Замена фильтра/ Техническое обслуживание

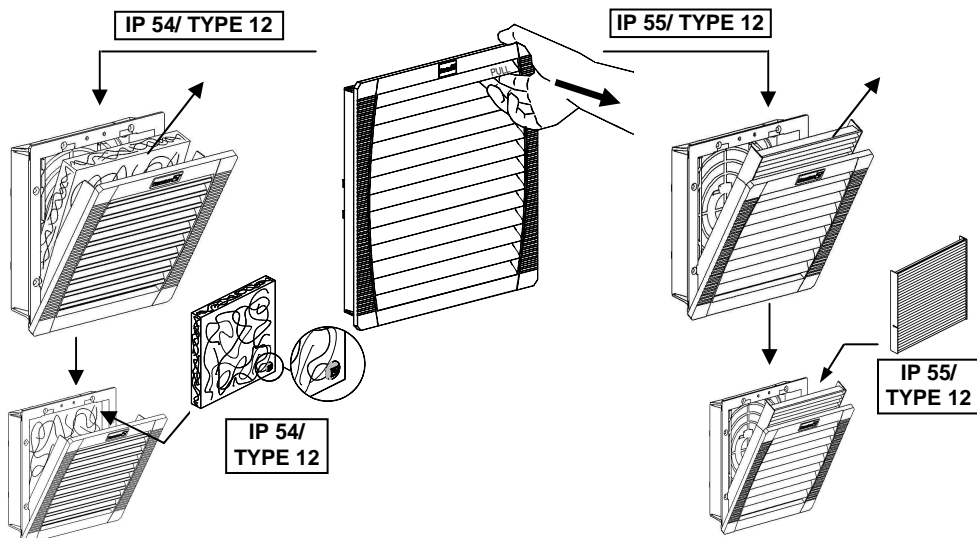

- Ⓓ IP 54/ 55/ TYPE 12: Auf korrekte Einbaulage des Filters achten
- Ⓖᅇ IP 54/ 55/ TYPE 12: Make sure that the filter is installed in the proper position.
- Ⓕ IP 54/ 55/ TYPE 12: Veuillez à insérer correctement le filtre
- Ⓕ IP 54/ 55/ TYPE 12: Op correcte inbouwpositie van het filter letten
- Ⓕ IP 54/ 55/ ZYPE 12: Beakta korrekt monteringslåge för filtret
- Ⓕ IP 54/ 55 /TYPE 12: Rispettare la corretta posizione di montaggio del filtro.
- Ⓕ IP 54/ 55 /TYPE 12: Procure que la posición de montaje del filtro sea la correcta
- Ⓕ IP 54/ 55/ TYPE 12: Следите за правильным положением фильтра

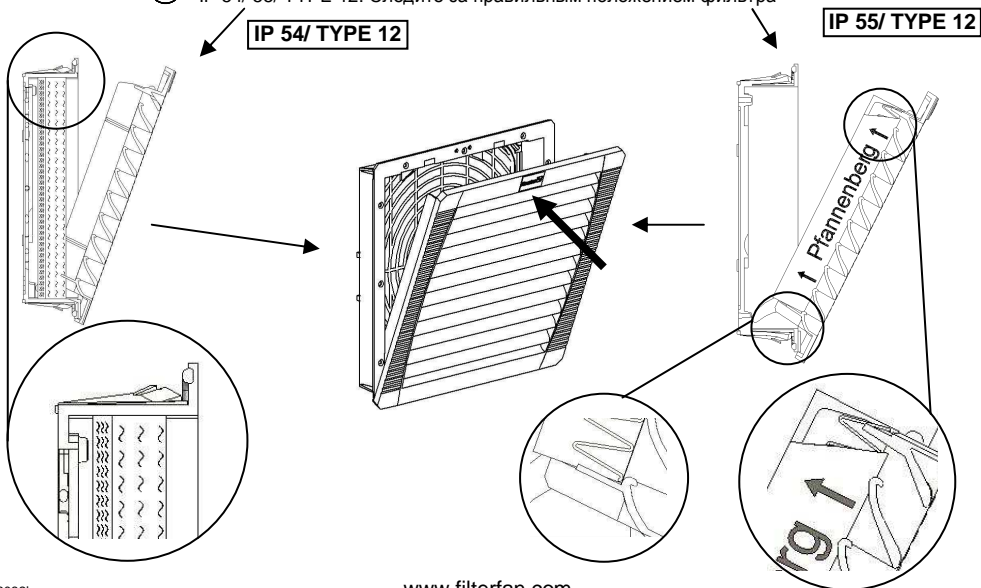

- (D) Wechsel der Luftförderrichtung
- (GB) Changing the air flow direction
- (F) Changement de la direction de l'air
- (NL) Omwisselen van de luchttransportrichting

- (S) Ändring av riktning för luftmatning
- (I) Cambio di direzione del flusso d'aria
- (E) Cambio de dirección del flujo de aire
- (RUS) Изменение направления движения воздуха

PF 1x.000 – PF 4x.000

PF 6x.000 SL

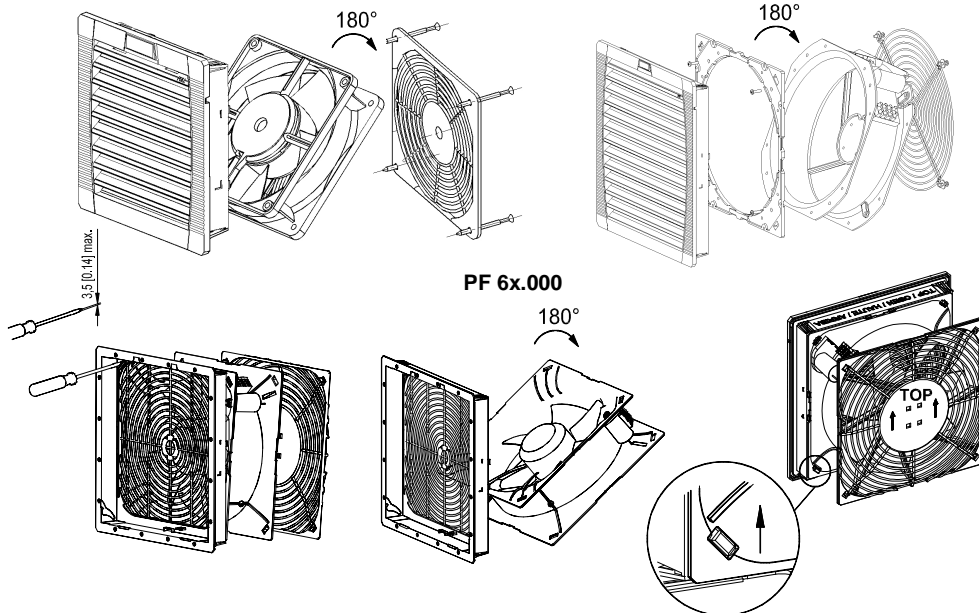

- (D) Verwenden Sie **ausschließlich Original Pfannenberg Ersatzteile**, anderenfalls erlöschen Gewährleistung und Zulassungen. Weiterhin sind bei Nichtverwendung der Original Ersatzteile Schutzarten und Leistungsdaten nicht mehr sichergestellt, die Schutzart reduziert sich dann auf Type 1.
- (GB) Warranty and licenses **are limited to original Pfannenberg spare parts** and become void if other spare parts are used. Furthermore, ingress protection and capacity levels are no longer ensured if original Pfannenberg spare parts are not used. As a result the ingress protection will be reduced to Type 1.
- (F) Veuillez utiliser **exclusivement les pièces détachées d'origine de Pfannenberg**, sinon la garantie et les homologations ne sont plus applicables. Il en va de même pour les types de protection et les caractéristiques de performance, la protection se réduit alors à type 1.
- (NL) Gebruik **uitsluitend originele onderdelen van Pfannenberg**, omdat anders garantiewaargen en certificeringen vervallen. Tevens zijn bij het niet gebruiken van originele onderdelen beveiligingsgraden en prestatiespecificaties niet langer gewaarborgd. In dit geval vermindert de beveiligingsgraden tot type 1.
- (S) Använd **uteslutande Pfannenbergs original reservdelar**, annars upphör garantin att gälla. Vidare kan eventuella fel eller reparationer som beror på att inte original Pfannenberg reservdelar används leda till att skyddsklass och effektdata inte längre säkerställas. I det tillfället skyddsklassen vilja reducera till på maskin 1.
- (I) Utilizzare **esclusivamente parti di ricambio originali Pfannenberg**, pena l'estinzione della garanzia e delle autorizzazioni. Inoltre, in caso di mancato utilizzo delle parti di ricambio originali, non sono più garantiti i tipi di protezione e le caratteristiche di funzionamento. Di conseguenza il grado di protezione sarà ridotto a tipo 1.
- (E) Utilice **únicamente repuestos originales de Pfannenberg**; de lo contrario, quedarán sin validez la garantía y las licencias. Además, en caso de no usar dichos repuestos originales, no se podrá garantizar la seguridad ni los datos de rendimiento. En este caso el tipo de protección se reduce al tipo 1.
- (RUS) Используйте **только оригинальные запасные части от фирмы Pfannenberg**, в противном случае прекращается действие гарантии и допуска к эксплуатации. Кроме того, мы не гарантируем при использовании неоригинальных деталей соблюдение требований по категории защиты и рабочих характеристик. Вид защиты в этом случае снижается до категории 1.





## Konformitätserklärung / Declaration of Conformity

gemäß den EG-Richtlinien / according to EC directives

- **Maschinenrichtlinie / Machinery directive 2006/42/EC**
- **Elektromagnetische Verträglichkeit / Electromagnetic compatibility 2004/108/EC**

### Die Geräte / The devices:

Hersteller / Manufacturer:	<b>Pfannenberg GmbH</b>
Produkt / Product:	<b>Filterlüfter / Filter Fan</b>
Type:	PF 11.000, PF 22.000, PF 32.000, PF 33.000, PF 42.500, PF 43.000, PF 65.000, PF 65000 –SL, PF 66.000, PF67000, PF 67.000 –SL, PFA 10.000, PFA 20.000, PFA 30.000, PFA 40.000, PFA 60.000

wurden entwickelt, konstruiert und gefertigt in Übereinstimmung mit den o.g. EU-Richtlinien, in alleiniger Verantwortung von:  
were developed, designed and manufactured to comply with the above-mentioned EC directives, under the sole responsibility of:

**Pfannenberg GmbH**  
**Werner-Witt-Str. 1**  
**D-21035 Hamburg**

Folgende harmonisierte Normen wurden angewandt / The following harmonised standards were applicable:

- DIN EN ISO 12100-2 (2004) Sicherheit von Maschinen - Grundbegriffe, allgemeine Gestaltungsleitsätze - Teil 1: Grundsätzliche Terminologie, Methodologie (ISO 12100-1:2003); Deutsche Fassung EN ISO 12100-1:2003+A1:2009  
Safety of machinery - Basic concepts, general principles for design - Part 1: Basic terminology, methodology (ISO 12100-1:2003); German version EN ISO 12100-1:2003+A1:2009
- DIN EN 60204-1 (2007) Sicherheit von Maschinen – Elektrische Ausrüstung von Maschinen – Teil 1: Allgemeine Anforderungen (IEC 60204-1:2005, modifiziert); Deutsche Fassung EN 60204-1:2006 +A1:2009  
Safety of machinery – Electrical equipment of machines – Part 1: General requirements (IEC 60204-1:2005, modified); German version EN 60204-1:2006 +A1:2009
- DIN EN 60335-2-80 (2009) Sicherheit elektrischer Geräte für den Hausgebrauch und ähnliche Zwecke - Teil 2-80: Besondere Anforderungen für Ventilatoren (IEC 60335-2-80:2002 + A1:2004 + A2:2008)  
Household and similar electrical appliances - Safety - Part 2-80: Particular requirements for fans
- DIN EN 61000-3-2 (2010) Elektromagnetische Verträglichkeit (EMV) - Teil 3-2: Grenzwerte - Grenzwerte für Oberschwingungsströme (Geräte-Eingangsstrom  $\leq 16$  A je Leiter) (IEC 61000-3-2:2005 + A1:2008 + A2:2009); Deutsche Fassung EN 61000-3-2:2006 + A1:2009 + A2:2009 / Electromagnetic compatibility (EMC) - Part 3-2: Limits - Limits for harmonic current emissions (equipment input current  $\leq 16$  A per phase) (IEC 61000-3-2:2005 + A1:2008 + A2:2009); German version EN 61000-3-2:2006 + A1:2009 + A2:2009
- DIN EN 61000-3-3 (2009) Elektromagnetische Verträglichkeit (EMV) - Teil 3-3: Grenzwerte - Begrenzung von Spannungsänderungen, Spannungsschwankungen und Flicker in öffentlichen Niederspannungs-Versorgungsnetzen für Geräte mit einem Bemessungsstrom  $\leq 16$  A je Leiter, die keiner Sonderanschlussbedingung unterliegen (IEC 61000-3-3:2008); Deutsche Fassung EN 61000-3-3:2008 / Electromagnetic compatibility (EMC) - Part 3-3: Limits - Limitation of voltage changes, voltage fluctuations and flicker in public low-voltage supply systems, for equipment with rated current  $\leq 16$  A per phase and not subject to conditional connection (IEC 61000-3-3:2008); German version EN 61000-3-3:2008
- DIN EN 61000-6-2 (2006) Fachgrundnorm, Störfestigkeit für Industriebereich / Electromagnetic compatibility (EMC), Generic standards; Immunity for industrial environments
- DIN EN 61000-6-3 (2007) Fachgrundnorm, Störaussendung im Wohnbereich / Electromagnetic compatibility (EMC), Generic standards; Emission standard for residential
- DIN EN 60529 (2000) Schutzarten durch Gehäuse (IP-Code) / Degrees of protection provided by enclosures (IP code)
- DIN IEC 60038 (2002) IEC-Normspannungen / IEC standard voltages

Folgende nationale Normen, Richtlinien und Spezifikationen wurden angewandt:  
The following standards, guidelines and specifications were applicable at national level:

- TRBS 2131 Elektrische Gefährdungen / electrical hazards
- GPSG Geräte- und Produktsicherheitsgesetz / German law - covering equipment and product safety

Eine Technische Dokumentation ist beim Hersteller vorhanden, die Montage-/Betriebsanleitung liegt dem Gerät bei. Die Sicherheitshinweise sind zu beachten. Diese Erklärung bescheinigt die Übereinstimmung mit den genannten Richtlinien.

Bevollmächtigte Person für die Zusammenstellung der technischen Unterlagen siehe Unterzeichner.  
The manufacturer is in possession of the technical documentation, the installation/operation instruction is attached to the device. The safety references are to be considered. This explanation certifies the agreement with the guidelines mentioned.  
Authorised person to compile the technical file see subscriber.

Hamburg, Oktober 2010  
P/N 085506618 Rev.Nr.:09

Nils Halm  
Technischer Leiter / Technical Director